

Learning of Rule Sets

- Introduction
 - Learning Rule Sets
 - Terminology
 - Coverage Spaces
- Separate-and-Conquer Rule Learning
 - Covering algorithm
 - Top-Down Hill-Climbing
 - Rule Evaluation Heuristics
 - Overfitting and Pruning
 - Multi-Class Problems
 - Bottom-Up Hill-Climbing

Learning Rule Sets

- many datasets cannot be solved with a single rule
 - not even the simple weather dataset
 - they need a rule set for formulating a target theory
- finding a computable generality relation for rule sets is not trivial
 - adding a condition to a rule specializes the theory
 - adding a new rule to a theory generalizes the theory
- practical algorithms use different approaches
 - covering or separate-and-conquer algorithms
 - based on heuristic search

A sample task

<i>Temperature</i>	<i>Outlook</i>	<i>Humidity</i>	<i>Windy</i>	<i>Play Golf?</i>
hot	sunny	high	false	no
hot	sunny	high	true	no
hot	overcast	high	false	yes
cool	rain	normal	false	yes
cool	overcast	normal	true	yes
mild	sunny	high	false	no
cool	sunny	normal	false	yes
mild	rain	normal	false	yes
mild	sunny	normal	true	yes
mild	overcast	high	true	yes
hot	overcast	normal	false	yes
mild	rain	high	true	no
cool	rain	normal	true	no
mild	rain	high	false	yes

- Task:
 - Find a rule set that correctly predicts the dependent variable from the observed variables

A Simple Solution

```
IF T=hot AND H=high AND O=overcast AND W=false THEN yes
IF T=cool AND H=normal AND O=rain AND W=false THEN yes
IF T=cool AND H=normal AND O=overcast AND W=true THEN yes
IF T=cool AND H=normal AND O=sunny AND W=false THEN yes
IF T=mild AND H=normal AND O=rain AND W=false THEN yes
IF T=mild AND H=normal AND O=sunny AND W=true THEN yes
IF T=mild AND H=high AND O=overcast AND W=true THEN yes
IF T=hot AND H=normal AND O=overcast AND W=false THEN yes
IF T=mild AND H=high AND O=rain AND W=false THEN yes
```

- The solution is
 - a set of rules
 - that is complete and consistent on the training examples
 - it must be part of the version space
- but it does not generalize to new examples!

The Need for a Bias

- rule sets can be generalized by
 - generalizing an existing rule (as usual)
 - introducing a new rule (this is new)
- a minimal generalization could be
 - introduce a new rule that covers only the new example
- Thus:
 - The solution on the previous slide will be found as a result of the FindS algorithm
 - FindG (or Batch-FindG) are less likely to find such a bad solution because they prefer general theories
- But in principle this solution is part of the hypothesis space and also of the version space
 - ⇒ we need a *search bias* to prevent finding this solution!

A Better Solution

IF Outlook = overcast	THEN	yes
IF Humidity = normal AND Outlook = sunny	THEN	yes
IF Outlook = rainy AND Windy = false	THEN	yes

Recap: Batch-Find

- Abstract algorithm for learning a single rule:

1. Start with an empty theory T and training set E
2. Learn a single (*consistent*) rule R from E and add it to T
3. return T

- Problem:

- the basic assumption is that the found rules are complete, i.e., they cover all positive examples
- What if they don't?

- Simple solution:

- If we have a rule that covers part of the positive examples:
- add some more rules that cover the remaining examples

Separate-and-Conquer Rule Learning

- Learn a set of rules, one by one

1. Start with an empty theory T and training set E
2. Learn a single (*consistent*) rule R from E and add it to T
3. If T is *satisfactory* (*complete*), return T
4. Else:
 - Separate: Remove examples explained by R from E
 - Conquer: goto 2.

- One of the oldest family of learning algorithms
 - goes back AQ (Michalski, 60s)
 - FRINGE, PRISM and CN2: relation to decision trees (80s)
 - popularized in ILP (FOIL and PROGOL, 90s)
 - RIPPER brought in good noise-handling
- Different learners differ in how they find a single rule

Relaxing Completeness and Consistency

- So far we have always required a learner to learn a complete and consistent theory
 - e.g., one rule that covers all positive and no negative examples
- This is not always a good idea (→ **overfitting**)
- Motivating Example:

Training set with 200 examples, 100 positive and 100 negative

 - **Theory A** consists of 100 complex rules, each covering a single positive example and no negatives
 - Theory A is **complete and consistent** on the training set
 - **Theory B** consists of a single rule, covering 99 positive and 1 negative example
 - Theory B is **incomplete and inconsistent** on the training set

Which one will generalize better to unseen examples?

Separate-and-Conquer Rule Learning

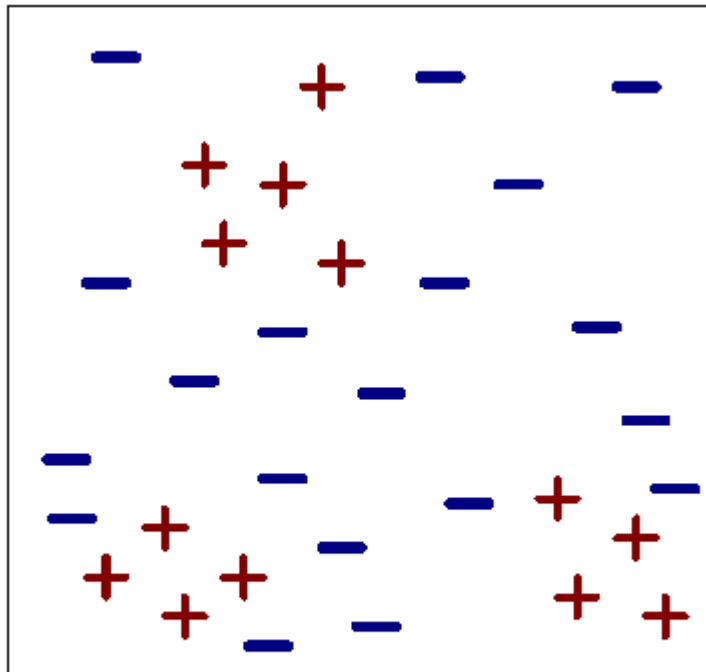

(i) Original Data

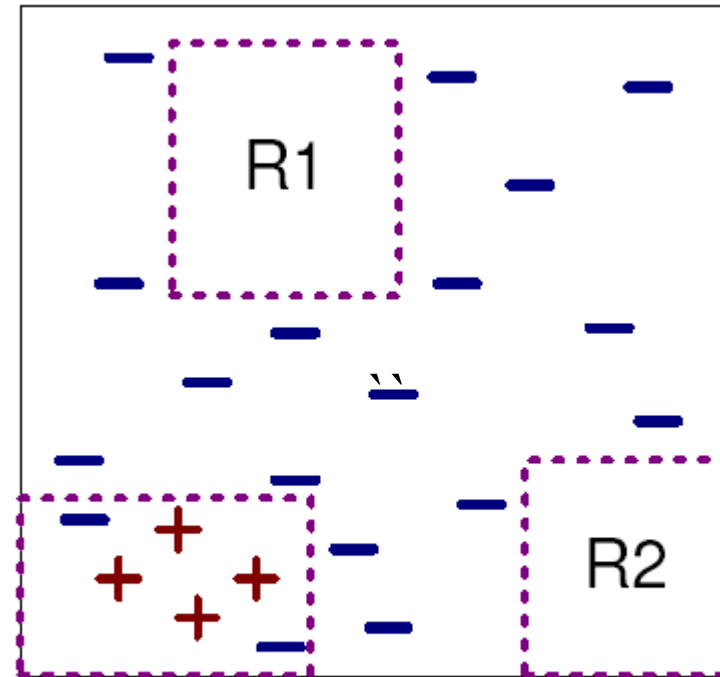

(iv) Step 3

Terminology

- training examples
 - P : total number of positive examples
 - N : total number of negative examples
- examples covered by the rule (predicted positive)
 - **true positives** p : positive examples covered by the rule
 - **false positives** n : negative examples covered by the rule
- examples not covered the rule (predicted negative)
 - **false negatives** $P-p$: positive examples not covered by the rule
 - **true negatives** $N-n$: negative examples not covered by the rule

	predicted +	predicted -	
class +	p (true positives)	$P-p$ (false negatives)	P
class -	n (false positives)	$N-n$ (true negatives)	N
	$p + n$	$P+N - (p+n)$	$P+N$

Coverage Spaces

- good tool for visualizing properties of covering algorithms
 - each point is a theory covering p positive and n negative examples

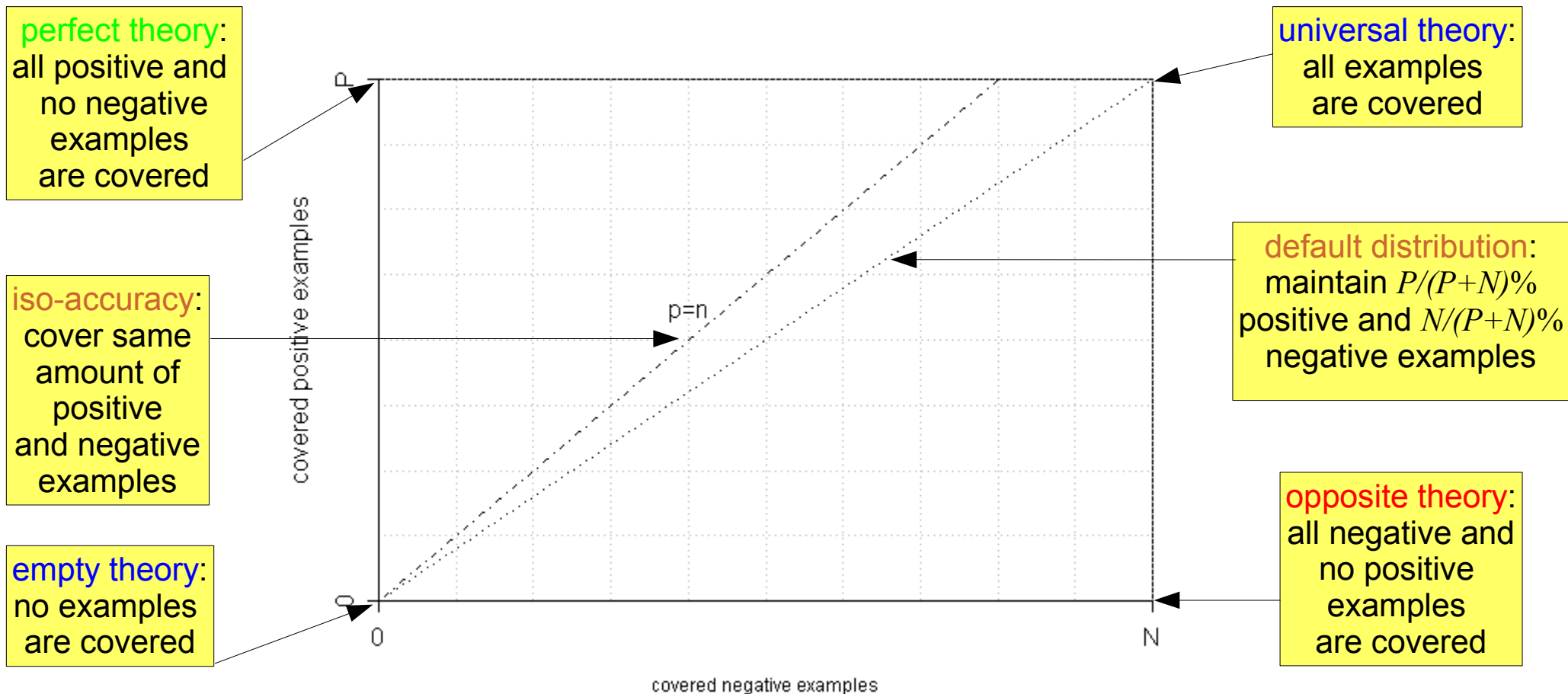

Covering Strategy

- Covering or Separate-and-Conquer rule learning algorithms learn one rule at a time
- This corresponds to a path in coverage space:
 - The **empty theory** R_0 (no rules) corresponds to $(0,0)$
 - Adding one rule **never decreases p or n** because adding a rule covers *more* examples (generalization)
 - The **universal theory** R_+ (all examples are positive) corresponds to (N,P)

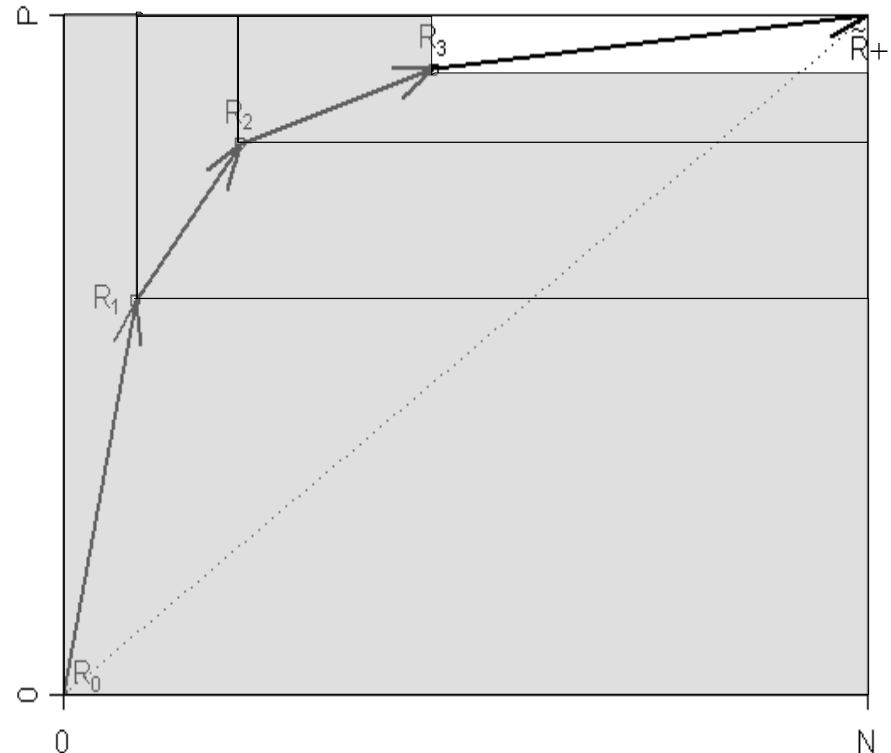

Top-Down Hill-Climbing

- **Top-Down** Strategy: A rule is successively *specialized*

1. Start with the universal rule R that covers all examples
2. Evaluate all possible ways to add a condition to R
3. Choose the best one (according to some heuristic)
4. If R is satisfactory, return it
5. Else goto 2.

- Almost all greedy s&c rule learning systems use this strategy

Top-Down Hill-Climbing

- successively extends a rule by adding conditions

- This corresponds to a path in coverage space:
 - The rule $p :- \text{true}$ covers all examples (universal theory)
 - Adding a condition never increases p or n (specialization)
 - The rule $p :- \text{false}$ covers no examples (empty theory)

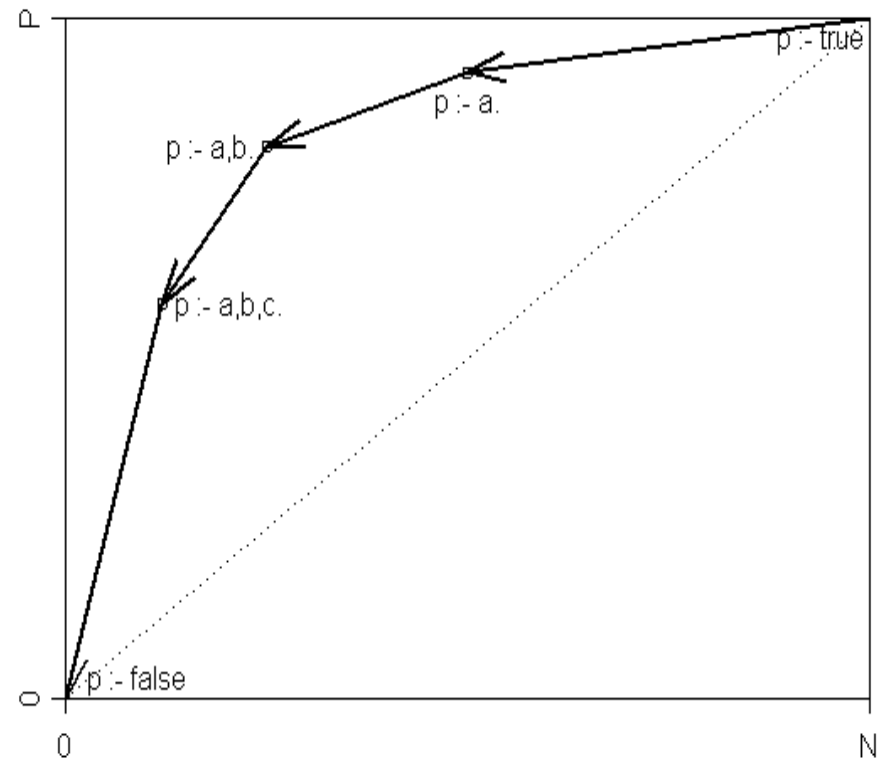

- which conditions are selected depends on a *heuristic function* that estimates the quality of the rule

Rule Learning Heuristics

- Adding a rule should
 - increase the number of covered negative examples as little as possible (do **not decrease consistency**)
 - increase the number of covered positive examples as much as possible (**increase completeness**)
- An evaluation heuristic should therefore trade off these two extremes
 - Example: **Laplace heuristic** $h_{Lap} = \frac{p+1}{p+n+2}$
 - grows with $p \rightarrow \infty$
 - grows with $n \rightarrow 0$
 - Note: Precision is not a good heuristic. Why?

$$h_{Prec} = \frac{p}{p+n}$$

Example

Condition		p	n	Precision	Laplace	p-n
Temperature =	Hot	2	2	0.5000	0.5000	0
	Mild	3	1	0.7500	0.6667	2
	Cold	4	2	0.6667	0.6250	2
Outlook =	Sunny	2	3	0.4000	0.4286	-1
	Overcast	4	0	1.0000	0.8333	4
	Rain	3	2	0.6000	0.5714	1
Humidity =	High	3	4	0.4286	0.4444	-1
	Normal	6	1	0.8571	0.7778	5
Windy =	True	3	3	0.5000	0.5000	0
	False	6	2	0.7500	0.7000	4

- Heuristics Precision and Laplace
 - add the condition Outlook= Overcast to the (empty) rule
 - stop and try to learn the next rule
- Heuristic Accuracy $/ p - n$
 - adds Humidity = Normal
 - continue to refine the rule (until no covered negative)

Isometrics in Coverage Space

- Isometrics are lines that connect points for which a function in p and n has equal values
 - *Examples:* Isometrics for heuristics $h_p = p$ and $h_n = -n$

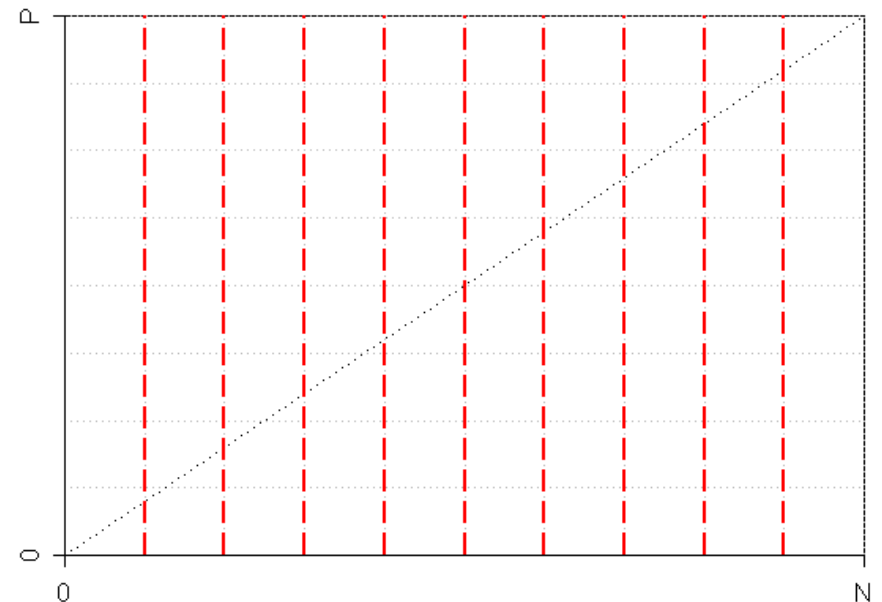
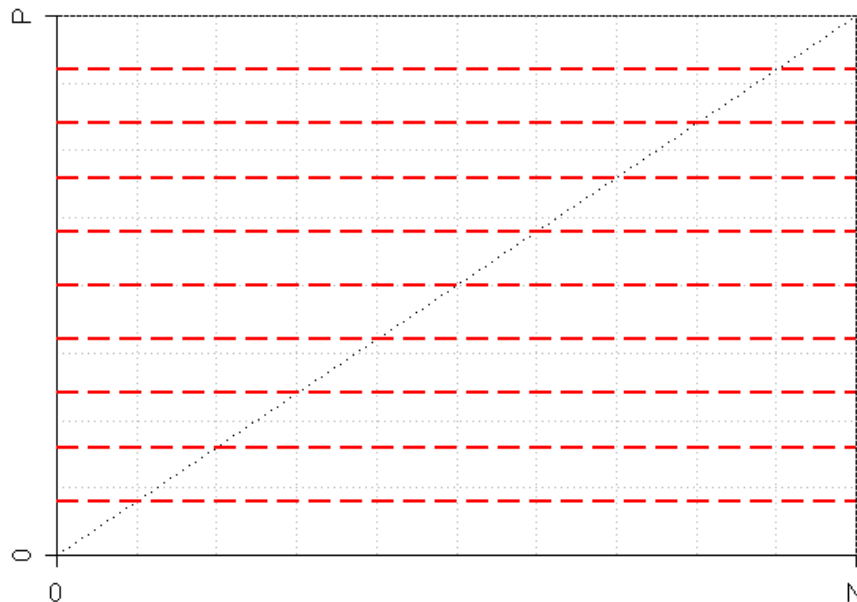

Precision (Confidence)

$$h_{Prec} = \frac{p}{p+n}$$

- *basic idea:*
percentage of positive examples among covered examples
- *effects:*
 - rotation around origin (0,0)
 - all rules with same angle equivalent
 - in particular, all rules on P/N axes are equivalent

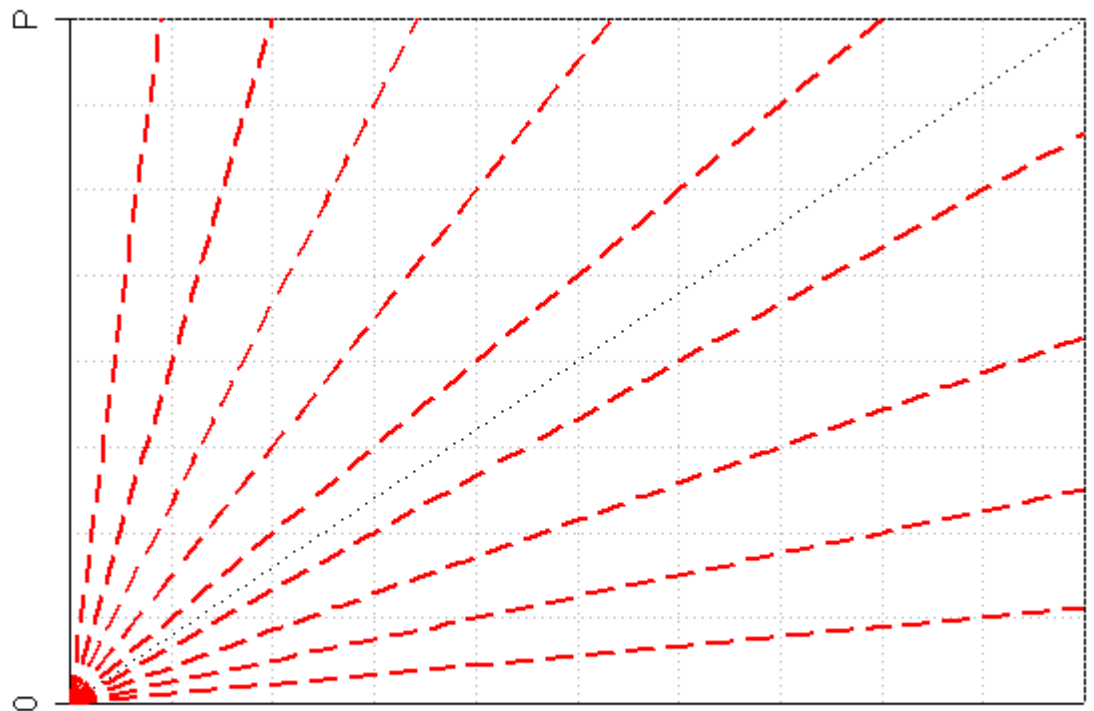

Entropy and Gini Index

- $$h_{Ent} = -\left(\frac{p}{p+n} \log_2 \frac{p}{p+n} + \frac{n}{p+n} \log_2 \frac{n}{p+n}\right)$$
- $$h_{Gini} = 1 - \left(\frac{p}{p+n}\right)^2 - \left(\frac{n}{p+n}\right)^2 \simeq \frac{pn}{(p+n)^2}$$

These will be explained later (decision trees)

- **effects:**

- entropy and Gini index are equivalent
- like precision, isometrics rotate around (0,0)
- isometrics are symmetric around 45° line
- a rule that only covers negative examples is as good as a rule that only covers positives

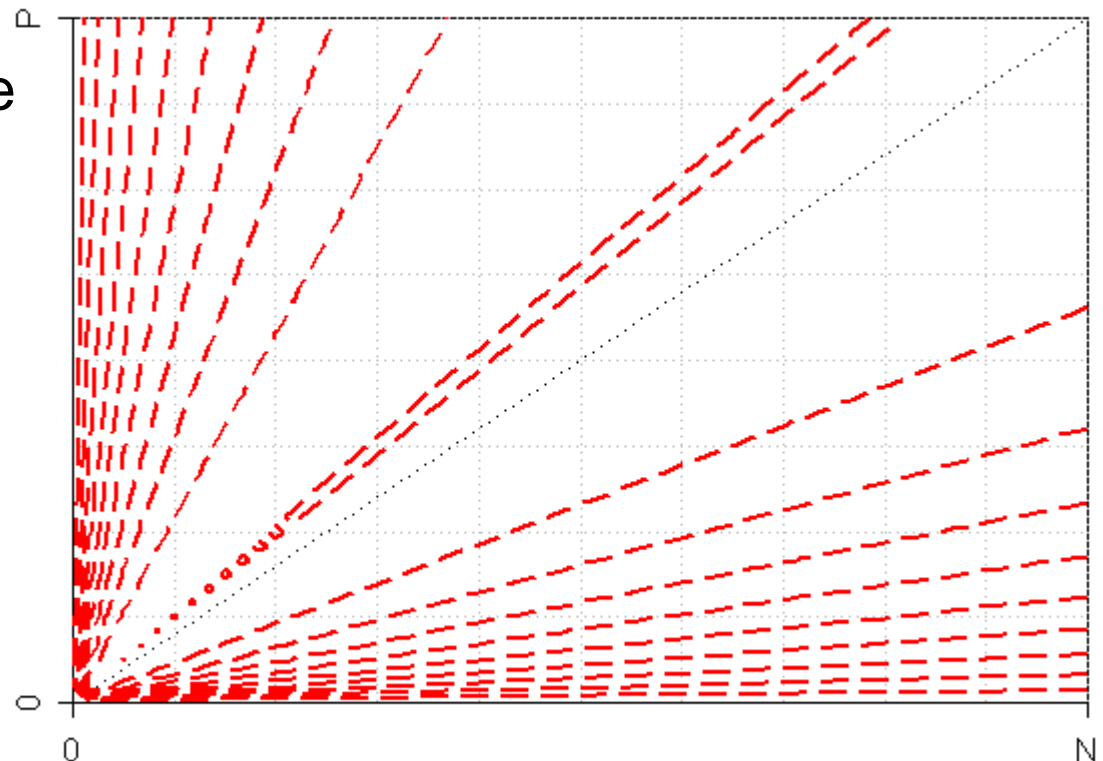

Accuracy

$$h_{Acc} = \frac{p + (N - n)}{P + N} \simeq p - n$$

Why are they equivalent?

- *basic idea:*
percentage of correct classifications
(covered positives plus uncovered negatives)
- *effects:*
 - isometrics are parallel to 45° line
 - covering one positive example is as good as not covering one negative example

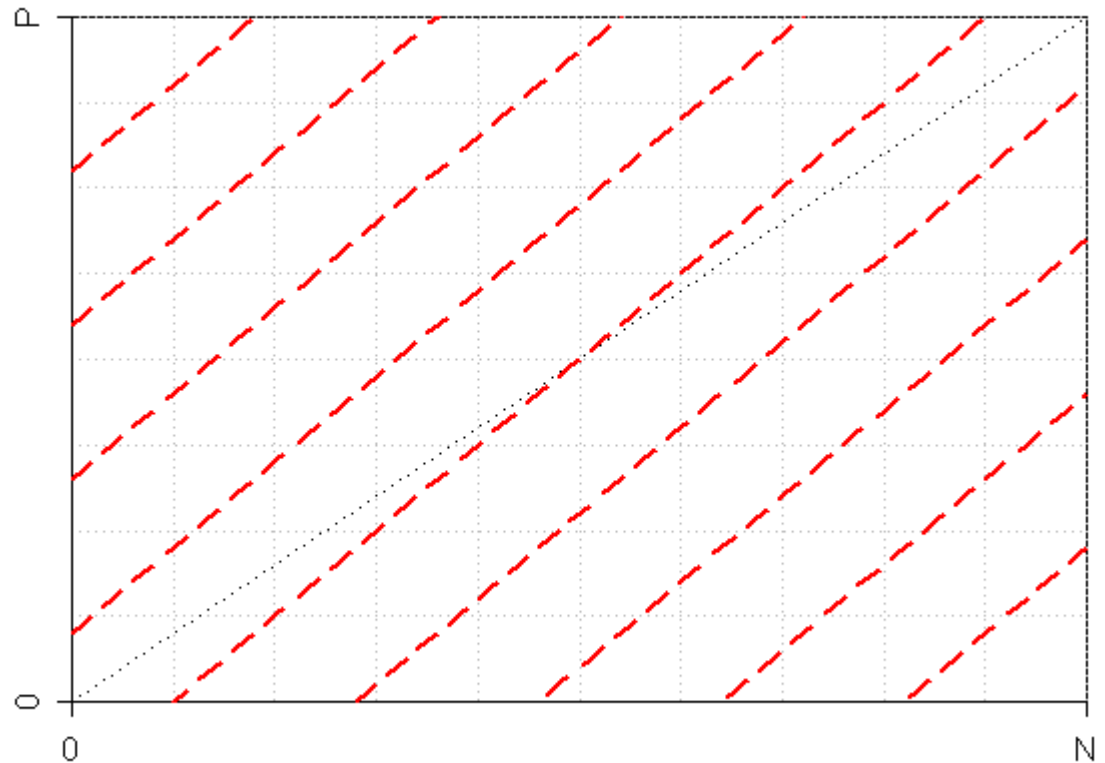

Weighted Relative Accuracy

$$h_{WRA} = \frac{p+n}{P+N} \left(\frac{p}{p+n} - \frac{P}{P+N} \right) \approx \frac{p}{P} - \frac{n}{N}$$

- *basic idea:*
normalize accuracy with the class distribution
- *effects:*
 - isometrics are parallel to diagonal
 - covering $x\%$ of the positive examples is considered to be as good as not covering $x\%$ of the negative examples

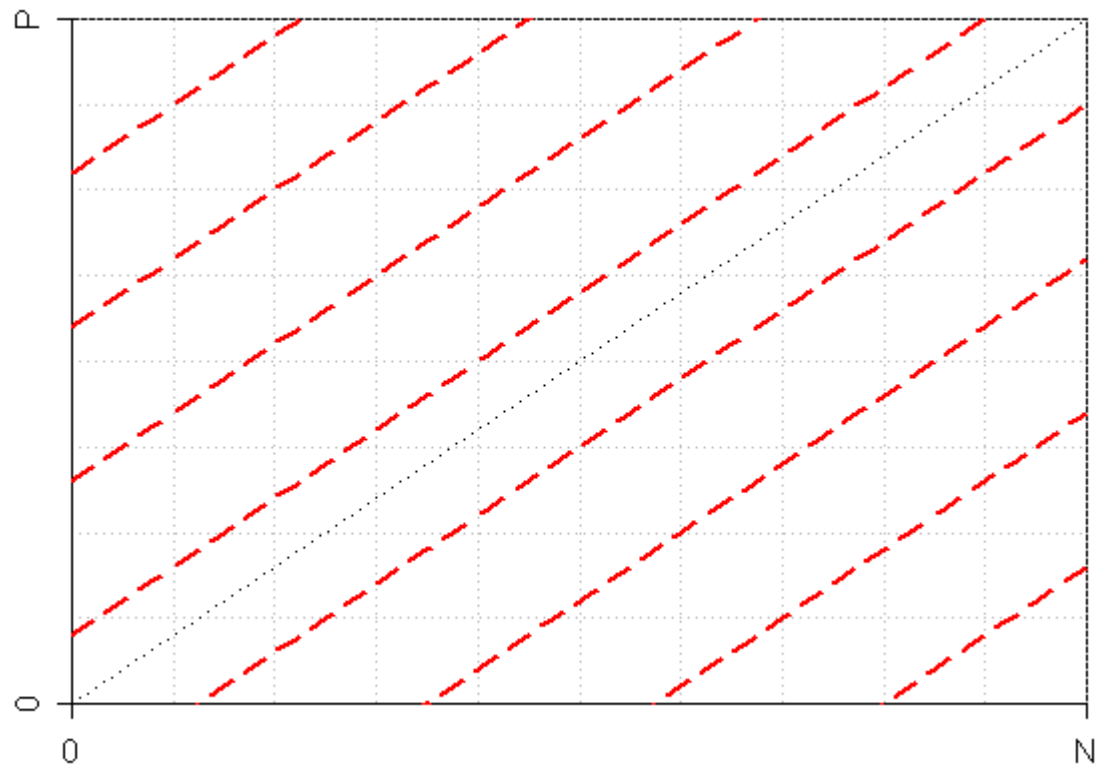

Weighted Relative Accuracy

- Two Basic ideas:

- **Precision Gain:** compare precision to precision of a rule that classifies randomly

$$\frac{p}{p+n} - \frac{P}{P+N}$$

- **Coverage:** Multiply with the percentage of covered examples

$$\frac{p+n}{P+N}$$

- Resulting formula:

$$h_{WRA} = \frac{p+n}{P+N} \cdot \left(\frac{p}{p+n} - \frac{P}{P+N} \right)$$

- one can show that sorts rules in exactly the same way as

$$h'_{WRA} = \frac{p}{P} - \frac{n}{N}$$

Linear Cost Metric

- Accuracy and weighted relative accuracy are only two special cases of the general case with linear costs:
 - costs c mean that covering 1 positive example is as good as not covering $c/(1-c)$ negative examples

c	<i>measure</i>
$\frac{1}{2}$	accuracy
$N/(P+N)$	weighted relative accuracy
0	excluding negatives at all costs
1	covering positives at all costs

- The general form is then $h_{cost} = c \cdot p - (1-c) \cdot n$
 - the isometrics of h_{cost} are parallel lines with slope $(1-c)/c$

Relative Cost Metric

- Defined analogously to the Linear Cost Metric
- Except that the trade-off is between the normalized values of p and n
 - between true positive rate p/P and false positive rate n/N

- The general form is then
$$h_{rcost} = c \cdot \frac{p}{P} - (1 - c) \cdot \frac{n}{N}$$
 - the isometrics of h_{cost} are parallel lines with slope $(1-c)/c$

- The plots look the same as for the linear cost metric
 - but the semantics of the c value is different:
 - for h_{cost} it does not include the example distribution
 - for h_{rcost} it includes the example distribution

Laplace-Estimate

- $$h_{Lap} = \frac{p+1}{(p+1)+(n+1)} = \frac{p+1}{p+n+2}$$

- **basic idea:**

precision, but count coverage for positive and negative examples starting with 1 instead of 0

- **effects:**

- origin at (-1,-1)
- different values on $p=0$ or $n=0$ axes
- not equivalent to precision

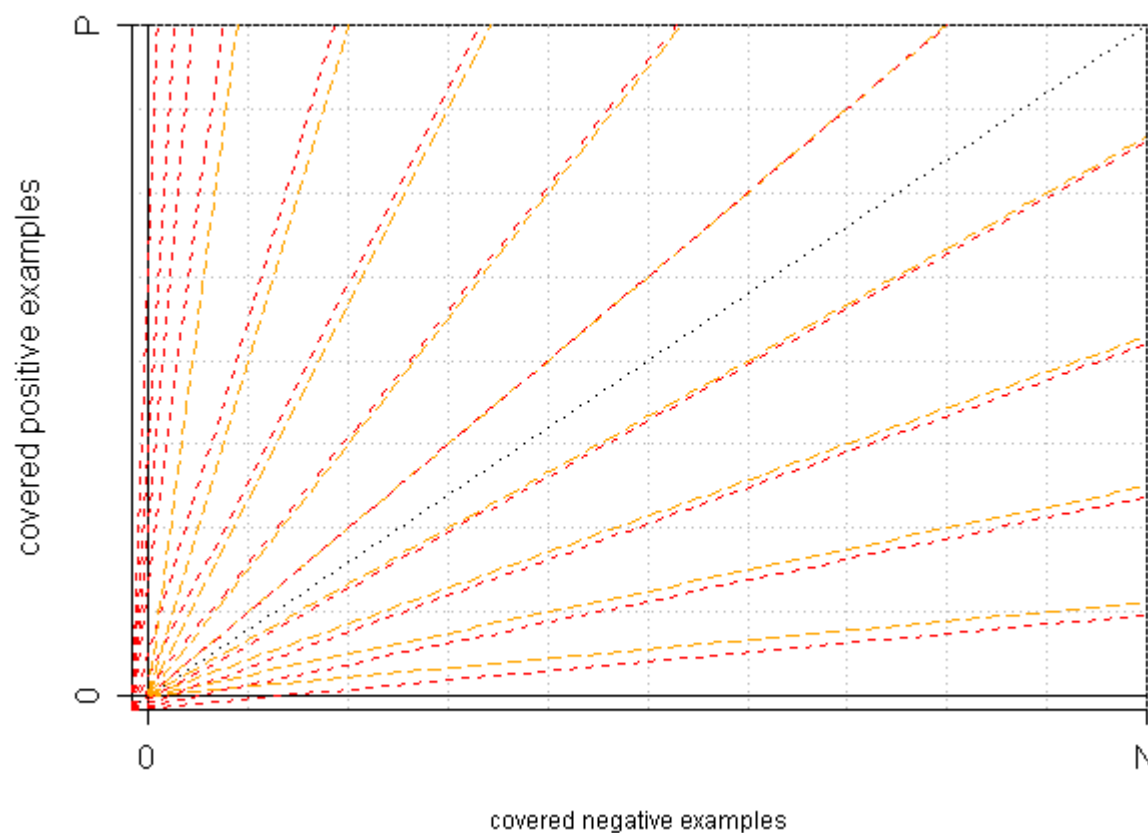

m-Estimate

- *basic idea:*
initialize the counts with m examples in total, distributed according to the prior distribution $P/(P+N)$ of p and n .
- *effects:*
 - origin shifts to $(-mP/(P+N), -mN/(P+N))$
 - with increasing m , the lines become more and more parallel
 - can be re-interpreted as a **trade-off between WRA and precision/confidence**

$$h_m = \frac{p + m \frac{P}{P+N}}{\left(p + m \frac{P}{P+N}\right) + \left(n + m \frac{N}{P+N}\right)} = \frac{p + m \frac{P}{P+N}}{p + n + m}$$

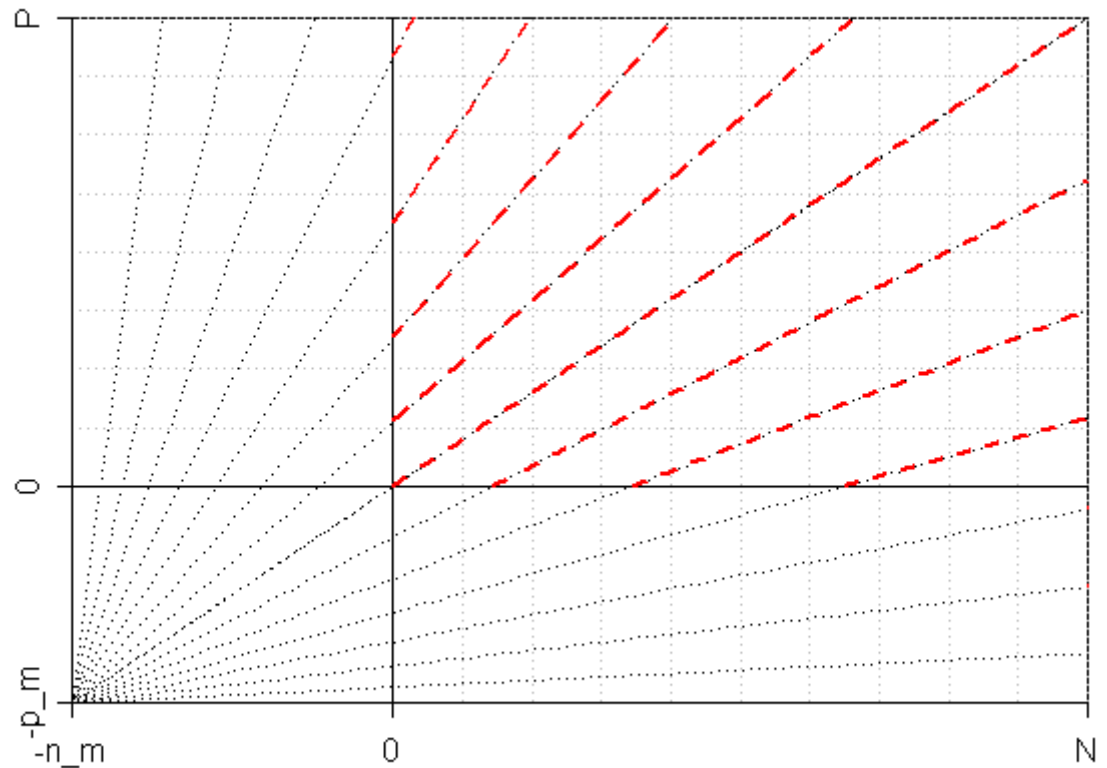

Generalized m-Estimate

- One can re-interpret the m-Estimate:
 - Re-interpret $c = N/(P+N)$ as a cost factor like in the general cost metric
 - Re-interpret m as a trade-off between precision and cost-metric
 - $m = 0$: precision (independent of cost factor)
 - $m \rightarrow \infty$: the isometrics converge towards the parallel isometrics of the cost metric
- Thus, the generalized m-Estimate may be viewed as a means of trading off between precision and the cost metric

Optimizing Precision

- Precision tries to pick the steepest continuation of the curve
 - tries to maximize the area under this curve (→ AUC: Area Under the ROC Curve)
 - no particular angle of isometrics is preferred, i.e. no preference for a certain cost model

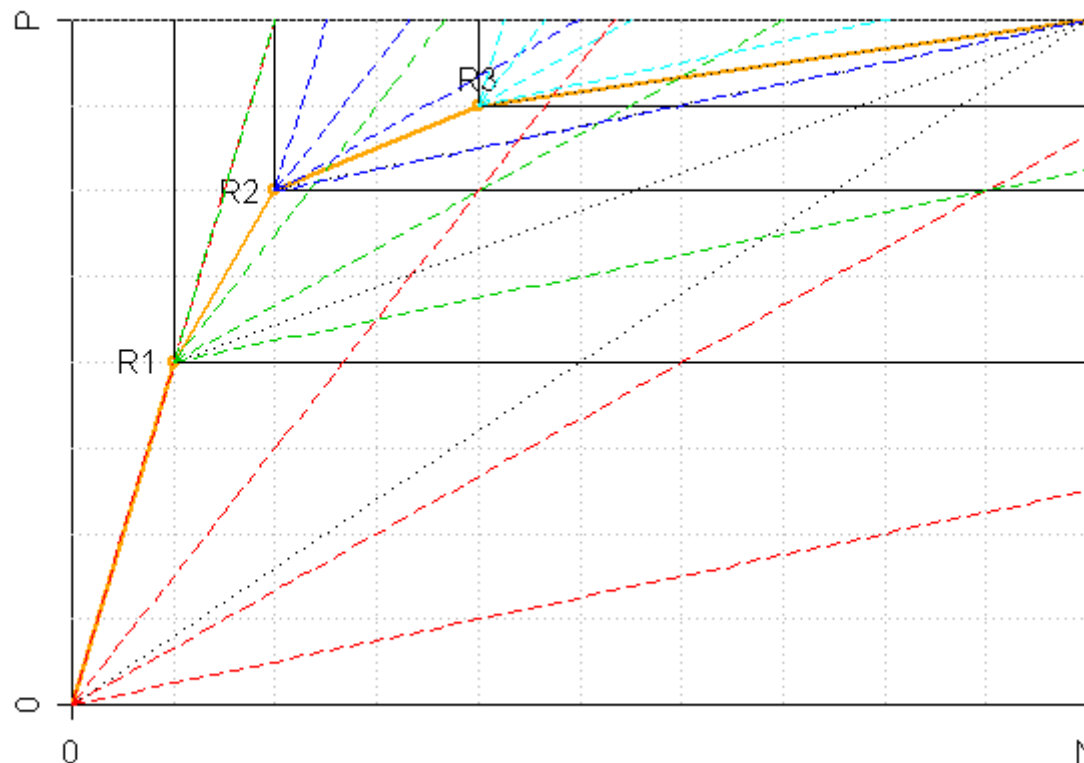

Optimizing Accuracy

- Accuracy assumes the same costs in all subspaces
 - a local optimum in a sub-space is also a global optimum in the entire space

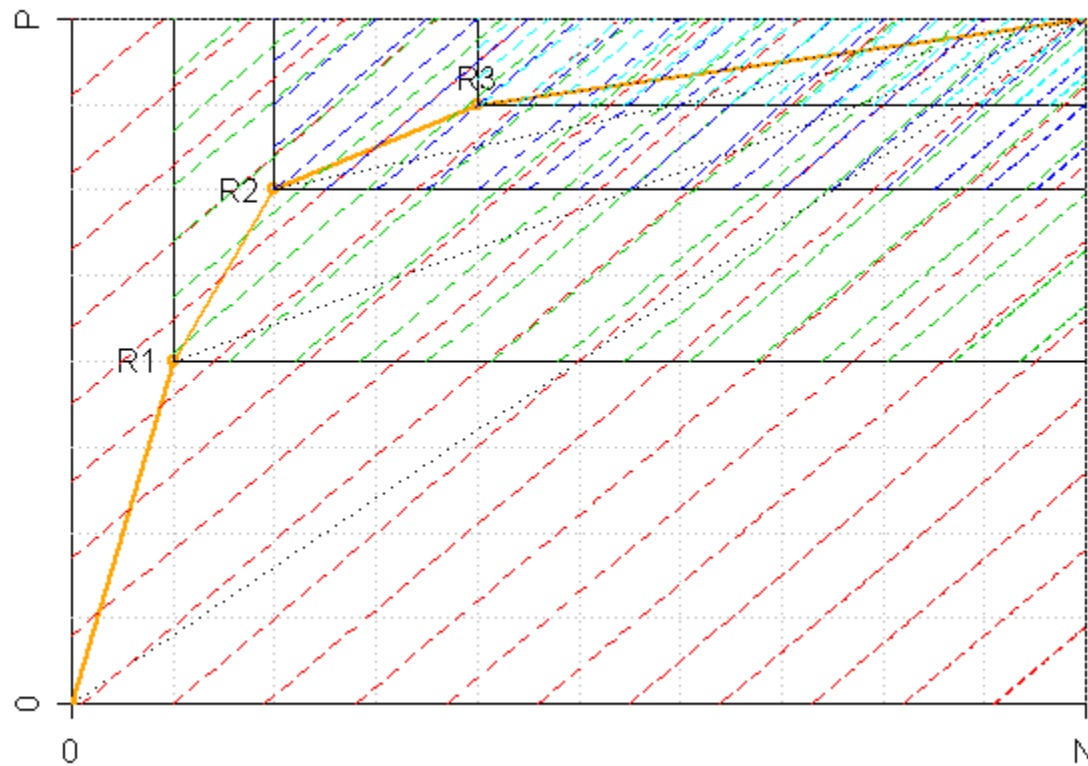

Summary of Rule Learning Heuristics

- There are two basic types of (linear) heuristics.
 - precision: rotation around the origin
 - cost metrics: parallel lines
- They have different goals
 - precision picks the steepest continuation for the curve for unkown costs
 - linear cost metrics pick the best point according to known or assumed costs
- The m-heuristic may be interpreted as a trade-off between the two prototypes
 - parameter c chooses the *cost model*
 - parameter m chooses the “*degree of parallelism*”

Correlation

$$h_{Corr} = \frac{p(N-n) - (P-p)n}{\sqrt{PN(p+n)(P-p+N-n)}}$$

- *basic idea:*
measure correlation coefficient of predictions with target
- *effects:*
 - non-linear isometrics
 - in comparison to WRA
 - prefers rules near the edges
 - steepness of connection of intersections with edges increases
 - equivalent to χ^2

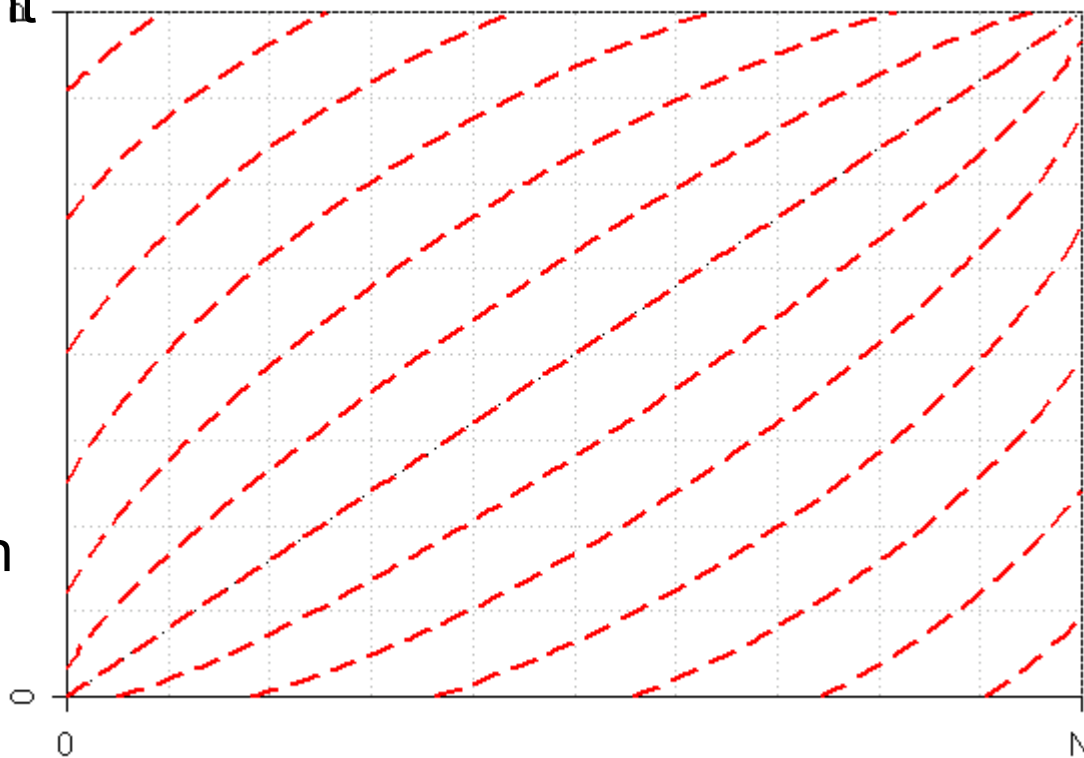

Foil Gain

$$h_{foil} = -p \left(\log_2 c - \log_2 \frac{p}{p+n} \right)$$

(c is the precision of the parent rule)

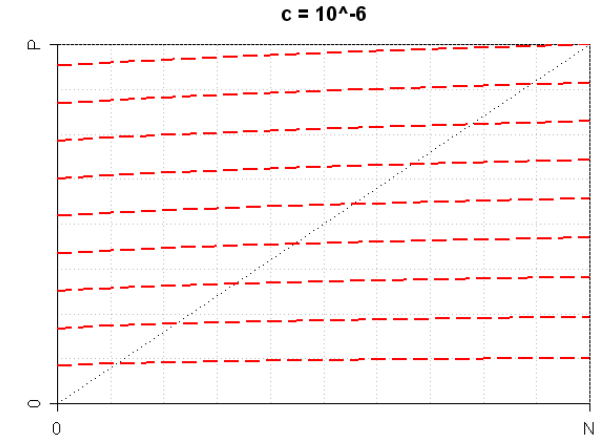
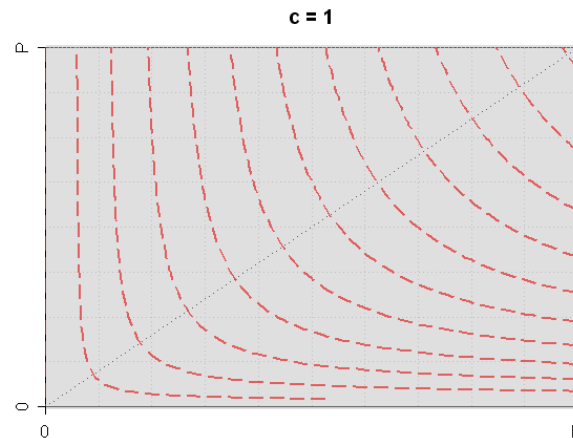
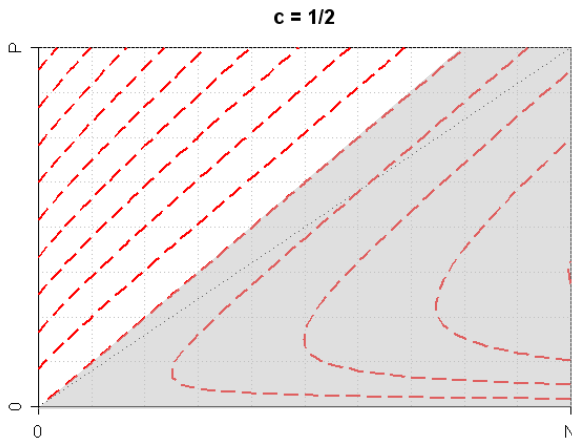
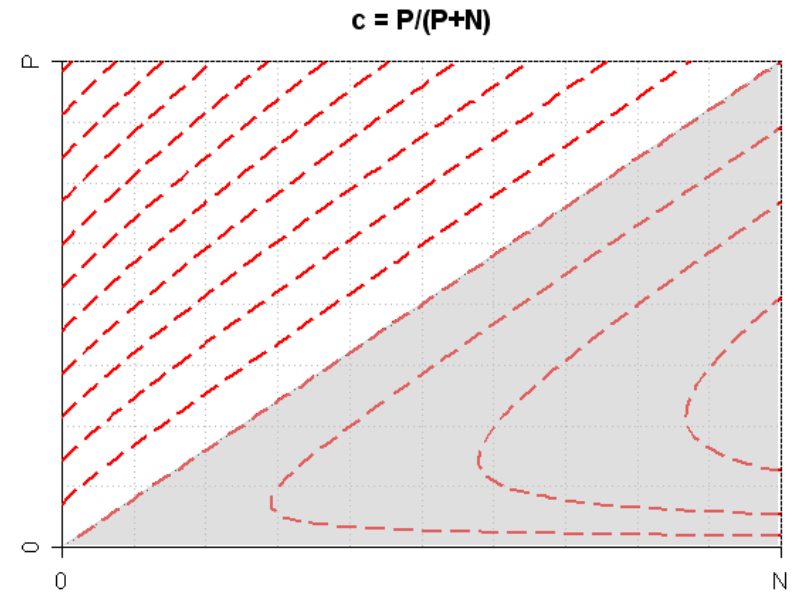

Which Heuristic is Best?

- There have been many proposals for different heuristics
 - and many different justifications for these proposals
 - some measures perform better on some datasets, others on other datasets
- Large-Scale Empirical Comparison:
 - 27 training datasets
 - on which parameters of the heuristics were tuned)
 - 30 independent datasets
 - which were not seen during optimization
 - Goals:
 - see which heuristics perform best
 - determine good parameter values for parametrized functions

Best Parameter Settings

for m-estimate: $m = 22.5$

m-Estimate

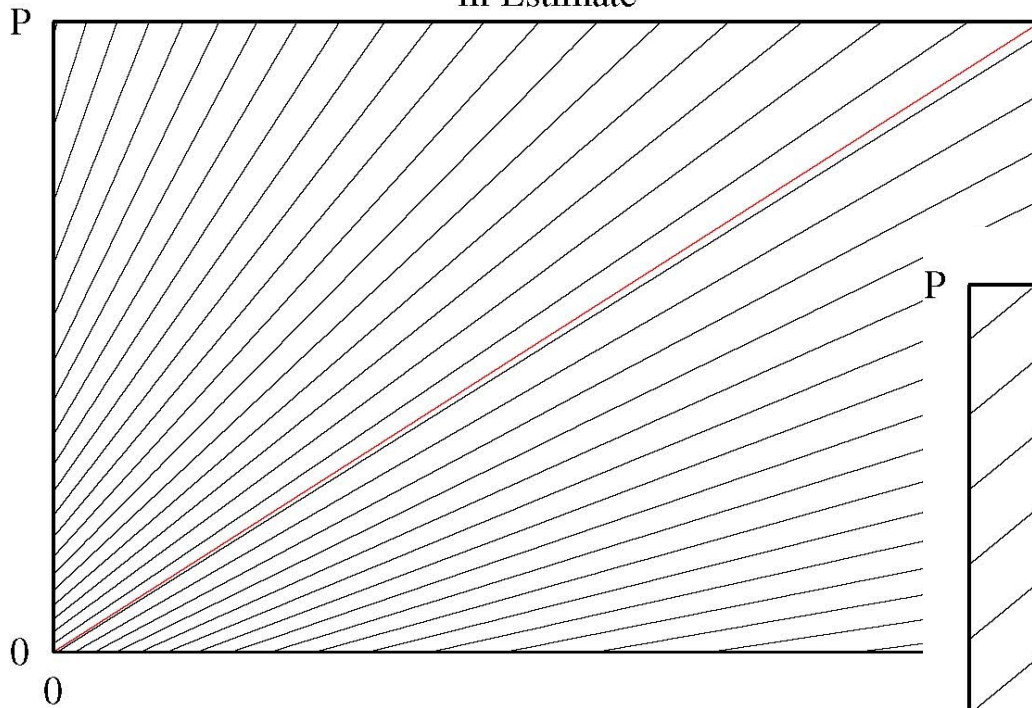

for relative cost metric: $c = 0.342$

Relative Linear Cost Metric

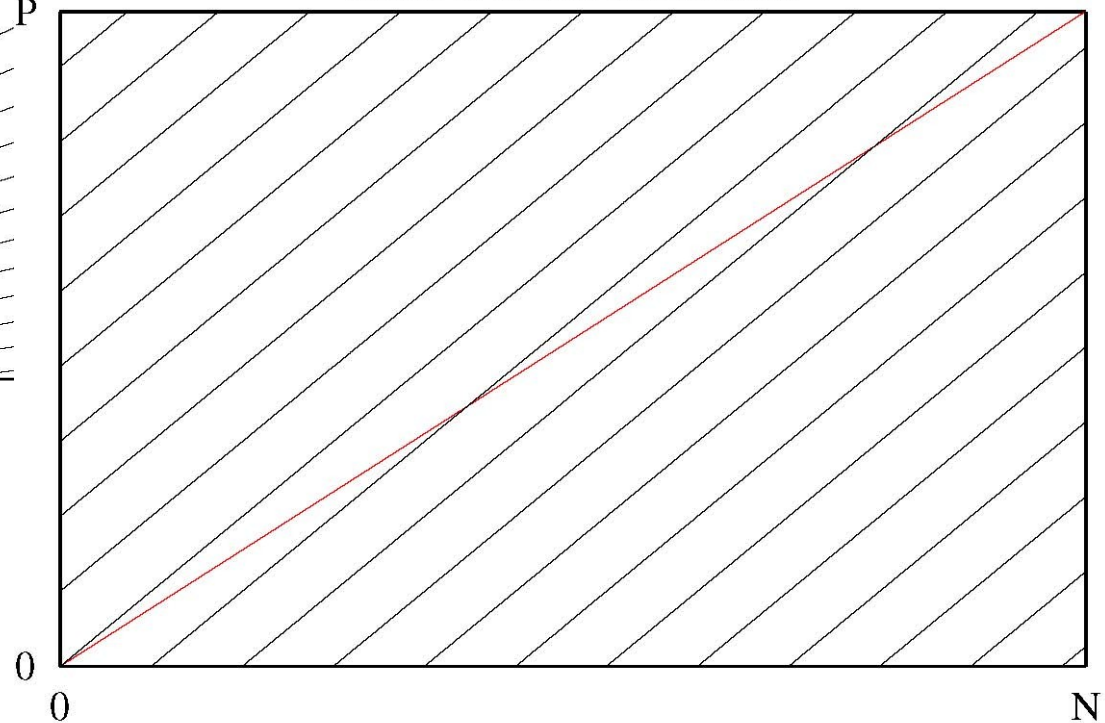

Empirical Comparison of Different Heuristics

Heuristic	Training Datasets		Independent Datasets	
	Accuracy	# Conditions	Accuracy	#Conditions
Ripper (JRip)	84,96	16,93	78,97	12,20
Relative Cost Metric (c =0.342)	85,63	26,11	78,87	25,30
m-Estimate (m = 22.466)	85,87	48,26	78,67	46,33
Correlation	83,68	37,48	77,54	47,33
Laplace	82,28	91,81	76,87	117,00
Precision	82,36	101,63	76,22	128,37
Linear Cost Metric (c = 0.437)	82,68	106,30	76,07	122,87
WRA	82,87	14,22	75,82	12,00
Accuracy	82,24	85,93	75,65	99,13

- Ripper is best, but uses pruning (the others don't)
- the optimized parameters for the m-estimate and the relative cost metric perform better than all other heuristics
 - also on the 30 datasets on which they were not optimized
- some heuristics clearly overfit (bad performance with large rules)
- WRA over-generalizes (bad performance with small rules)

Overfitting

- Overfitting
 - Given
 - a fairly general model class
 - enough degrees of freedom
 - you can always find a model that explains the data
 - even if the data contains error (**noise** in the data)
 - in rule learning: each example is a rule
- Such concepts do not generalize well!
 - → Pruning

Overfitting - Illustration

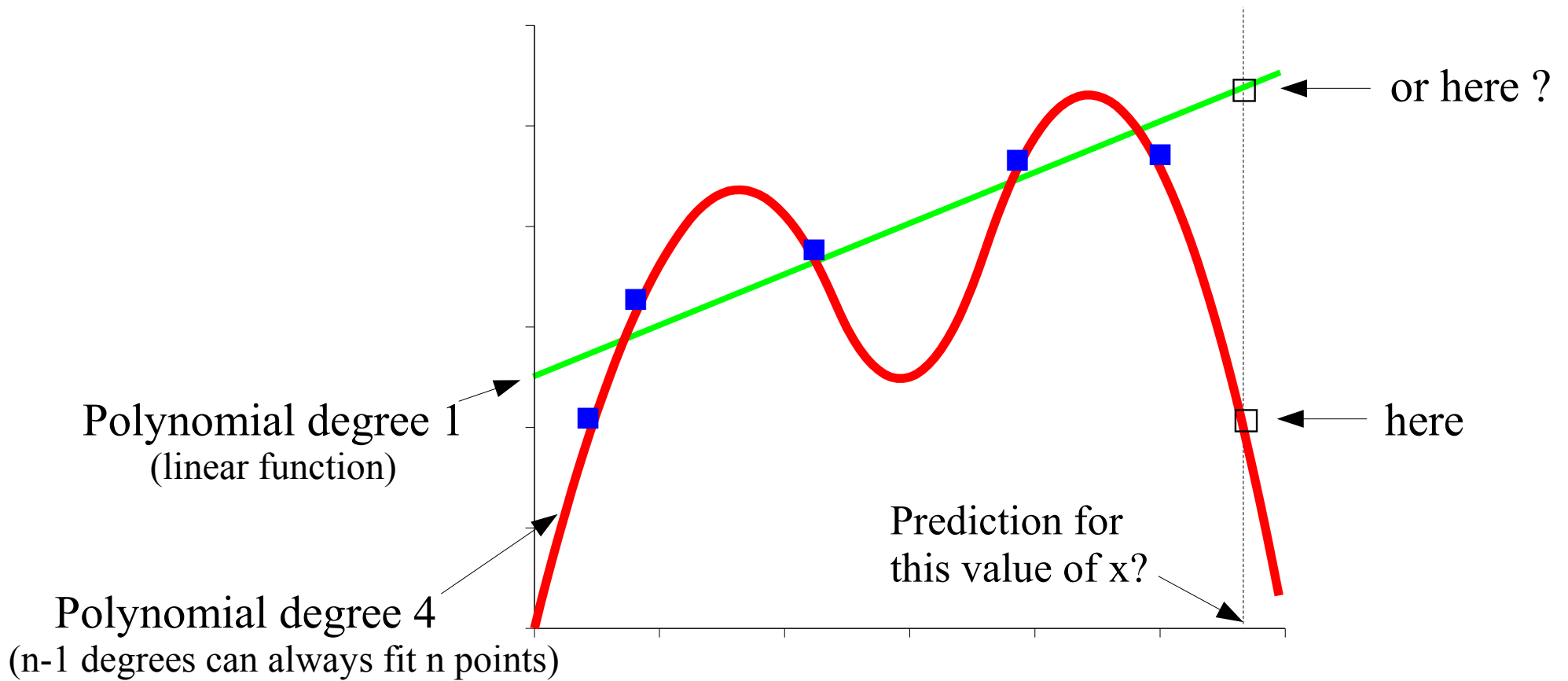

Overfitting

- Eine perfekte Anpassung an die gegebenen Daten ist nicht immer sinnvoll
 - Daten könnten fehlerhaft sein
 - z.B. zufälliges Rauschen (Noise)
 - Die Klasse der gewählten Funktionen könnte nicht geeignet sein
 - eine perfekte Anpassung an die Trainingsdaten ist oft gar nicht möglich
- Daher ist es oft günstig, die Daten nur ungefähr anzupassen
 - bei Kurven:
 - nicht alle Punkte müssen auf der Kurve liegen
 - beim Konzept-Lernen:
 - nicht alle positiven Beispiele müssen von der Theorie abgedeckt werden
 - einige negativen Beispiele dürfen von der Theorie abgedeckt werden

Overfitting

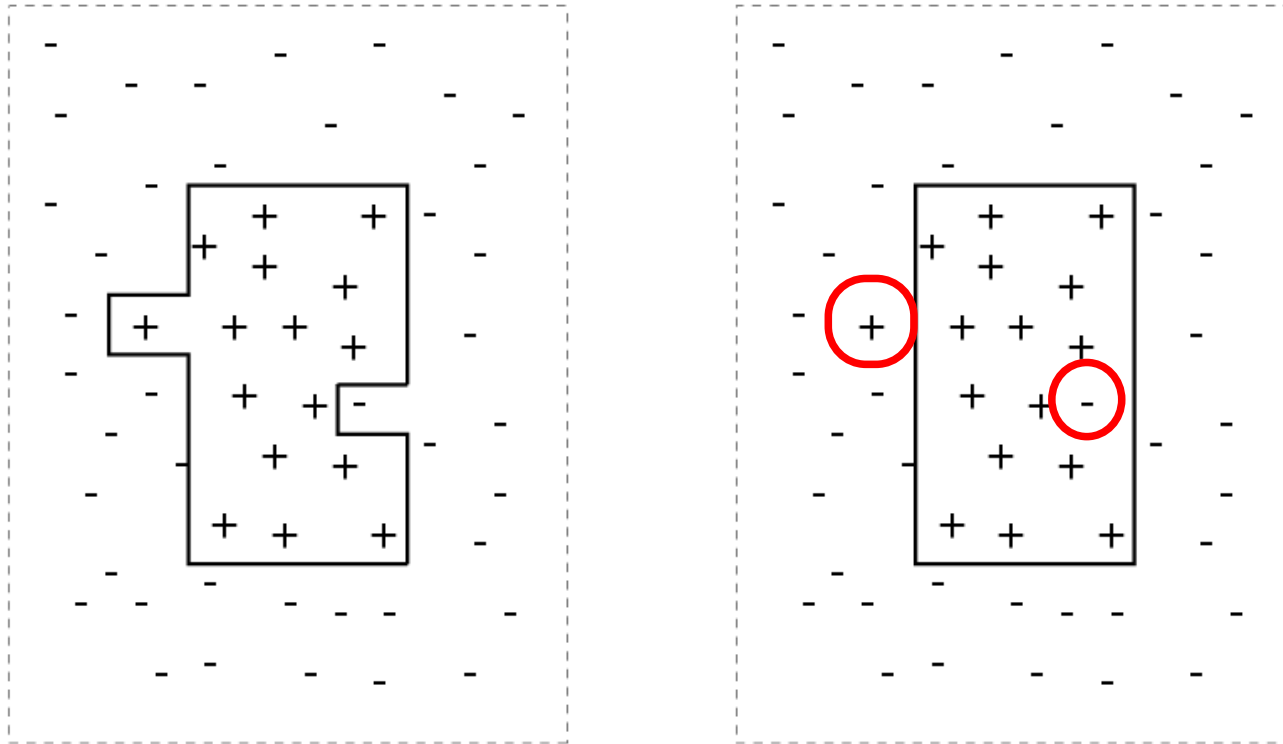

- beim Konzept-Lernen:
 - nicht alle positiven Beispiele müssen von der Theorie abgedeckt werden
 - einige negativen Beispiele dürfen von der Theorie abgedeckt werden

Komplexität von Konzepten

- Je weniger komplex ein Konzept ist, desto geringer ist die Gefahr, daß es sich zu sehr den Daten anpaßt
 - Für ein Polynom n -ten Grades kann man $n+1$ Parameter wählen, um die Funktion an alle Punkte anzupassen
- Daher wird beim Lernen darauf geachtet, die Größe der Konzepte klein zu halten
 - eine kurze Regel, die viele positive Beispiele erklärt (aber eventuell auch einige negative) ist oft besser als eine lange Regel, die nur einige wenige positive Beispiele erklärt.
- **Pruning:** komplexe Regeln werden zurechtgestutzt
 - **Pre-Pruning:**
 - während des Lernens
 - **Post-Pruning:**
 - nach dem Lernen

Pre-Pruning

- keep a theory simple *while* it is learned
 - decide when to **stop adding conditions** to a rule (*relax consistency constraint*)
 - decide when to **stop adding rules** to a theory (*relax completeness constraint*)
- efficient but not accurate

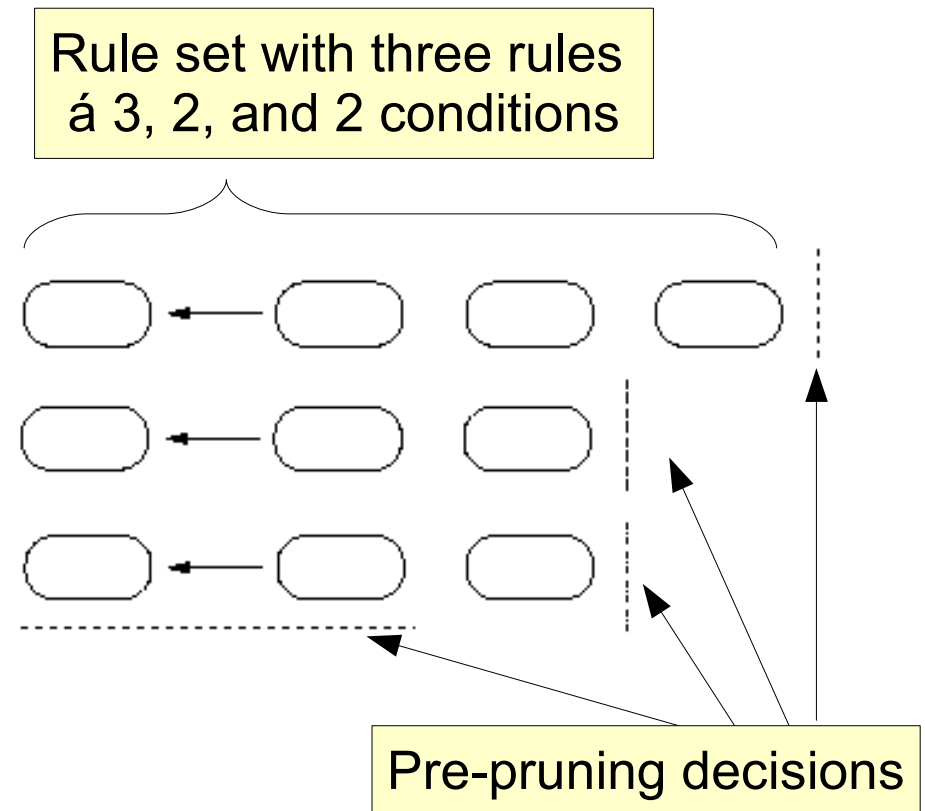

Pre-Pruning Heuristics

1. Thresholding a heuristic value

- require a certain minimum value of the search heuristic
- e.g.: Precision > 0.8 .

2. Foil's Minimum Description Length Criterion

- the length of the theory plus the exceptions (misclassified examples) must be shorter than the length of the examples by themselves
- lengths are measured in bits (information content)

3. CN2's Significance Test

- tests whether the distribution of the examples covered by a rule deviates significantly from the distribution of the examples in the entire training set
- if not, discard the rule

Minimum Coverage Filtering

filter rules that do not cover a minimum number of

positive examples (**support**)

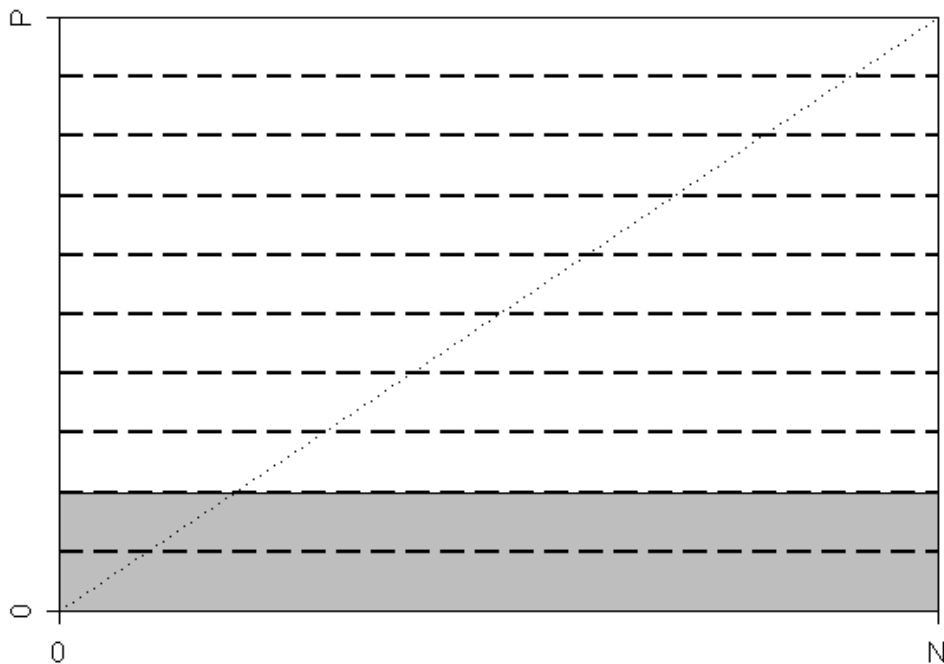

all examples (**coverage**)

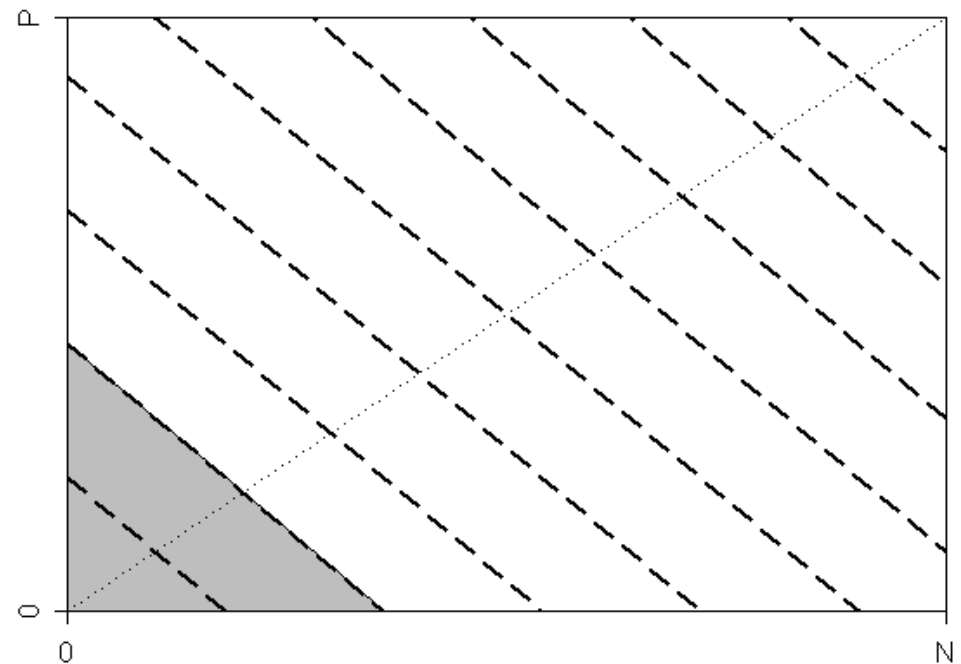

Support/Confidence Filtering

- filter rules that
 - cover not enough positive examples ($p < \text{supp}_{min}$)
 - are not precise enough ($h_{prec} < \text{conf}_{min}$)
- *effects:*
 - all but a region around $(0, P)$ is filtered

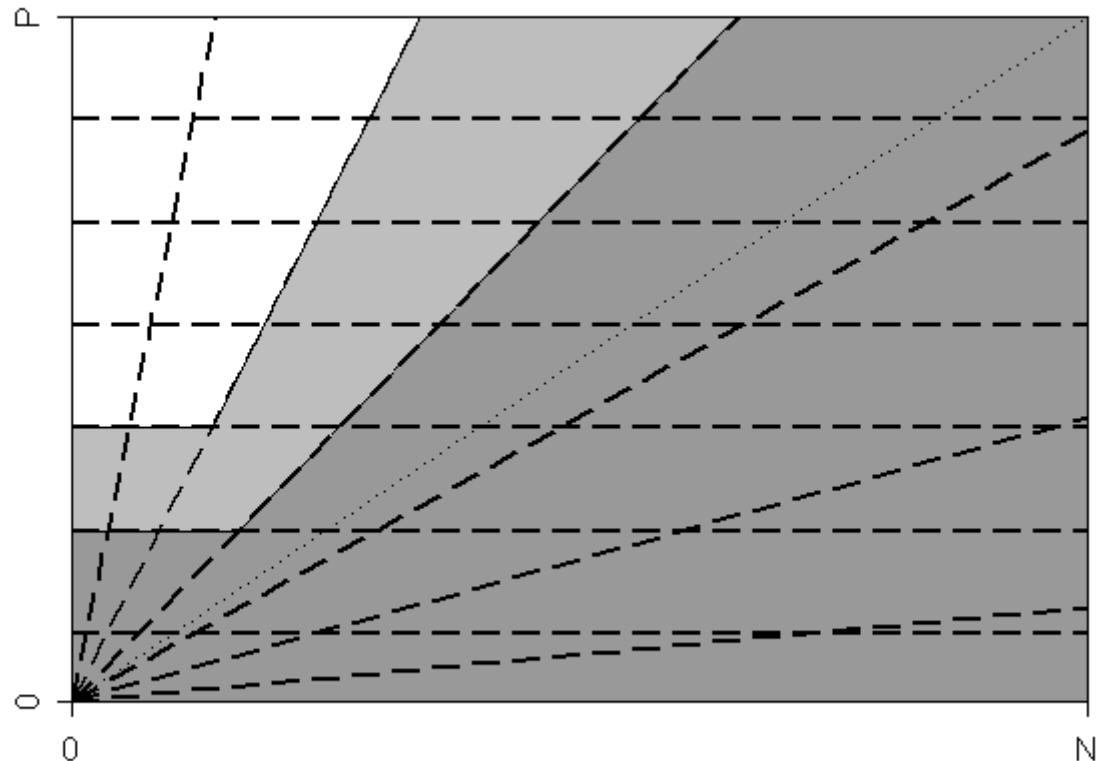

→ we will return to support/confidence in the context of association rule learning algorithms!

CN2's likelihood ratio statistics

$$h_{LRS} = 2 \left(p \log \frac{p}{e_p} + n \log \frac{n}{e_n} \right)$$

$$e_p = (p+n) \frac{P}{P+N}; \quad e_n = (p+n) \frac{N}{P+N}$$

are the expected number of positive and negative example in the $p+n$ covered examples.

- *basic idea:*
measure significant deviation from prior probability distribution
- *effects:*
 - non-linear isometrics
 - similar to m-estimate
 - but prefer rules near the edges
 - distributed χ^2
 - significance levels 95% (dark) and 99% (light grey)

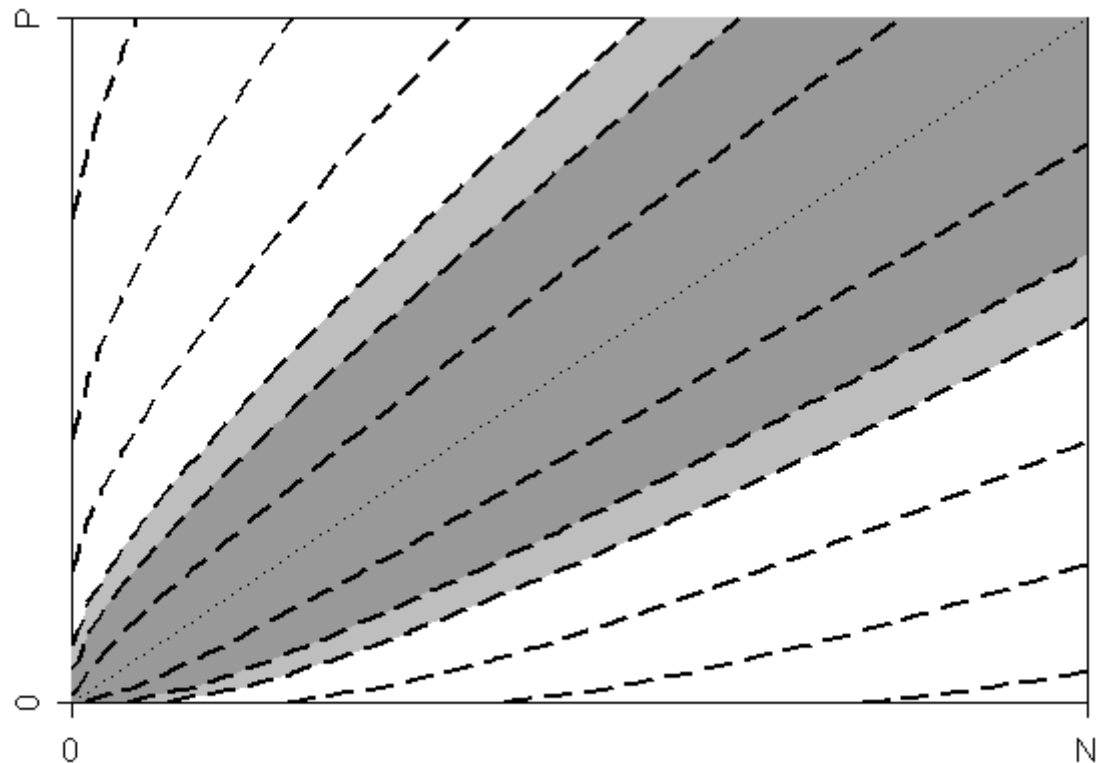

Correlation

$$h_{\text{Corr}} = \frac{p(N-n) - (P-p)n}{\sqrt{PN(p+n)(P-p+N-n)}}$$

- *basic idea:*
measure correlation coefficient of predictions with target
- *effects:*
 - non-linear isometrics
 - in comparison to WRA
 - prefers rules near the edges
 - steepness of connection of intersections with edges increases
 - equivalent to χ^2
 - grey area = cutoff of 0.3

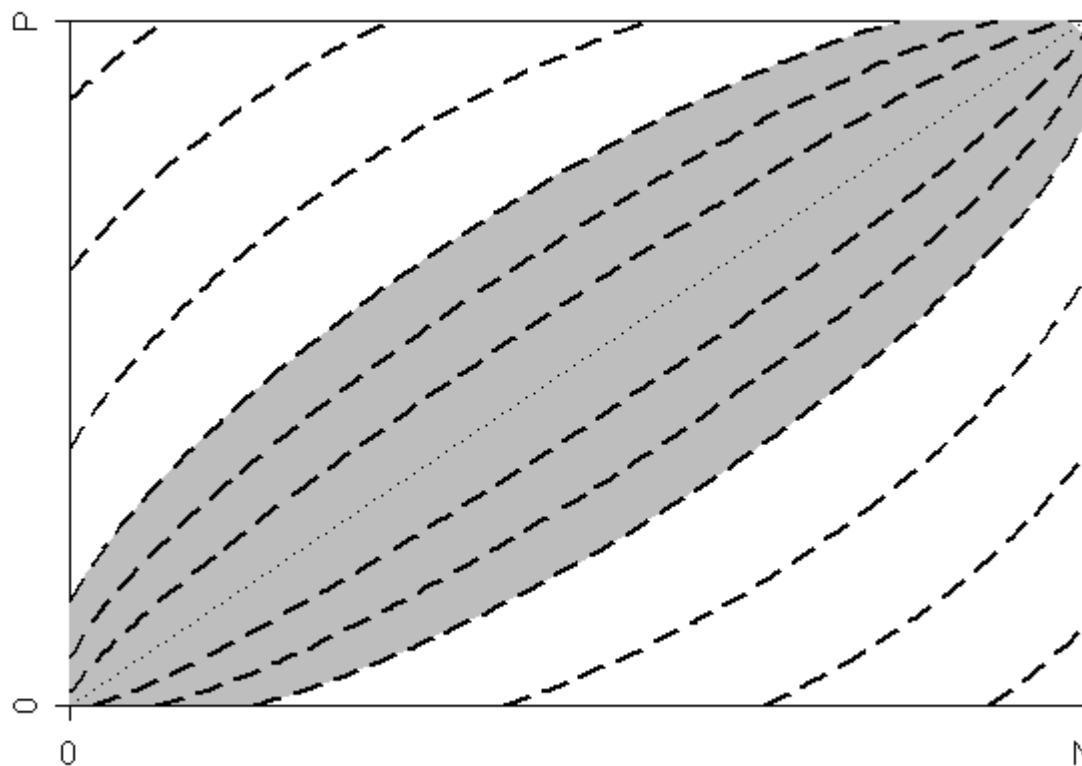

MDL-Pruning in Foil

- based on the **Minimum Description Length-Principle (MDL)**
 - is it more effective to transmit the rule or the covered examples?
 - compute the information contents of the rule (in bits)
 - compute the information contents of the examples (in bits)
 - if the rule needs more bits than the examples it covers, one can directly transmit the examples → no need to further refine the rule
 - Details → (Quinlan, 1990)
- doesn't work all that well
 - if rules have exceptions (i.e., are inconsistent), the negative examples must be encoded as well
 - they must be transmitted, otherwise the receiver could not reconstruct which examples do not conform to the rule
 - finding a minimal encoding (in the information-theoretic sense) is practically impossible

Foil's MDL-based Stopping Criterion

costs for transmitting how many examples we have (can be ignored)

$$h_{MDL} = \log_2(P+N) + \log_2 \binom{P+N}{p}$$

costs for transmitting which of the $P+N$ examples are covered and positive

- *basic idea:*
compare the encoding length of the rule $l(r)$ to the encoding length h_{MDL} of the example.
 - we assume $l(r) = c$ constant
- *effects:*
 - equivalent to filtering on support
 - because function only depends on p

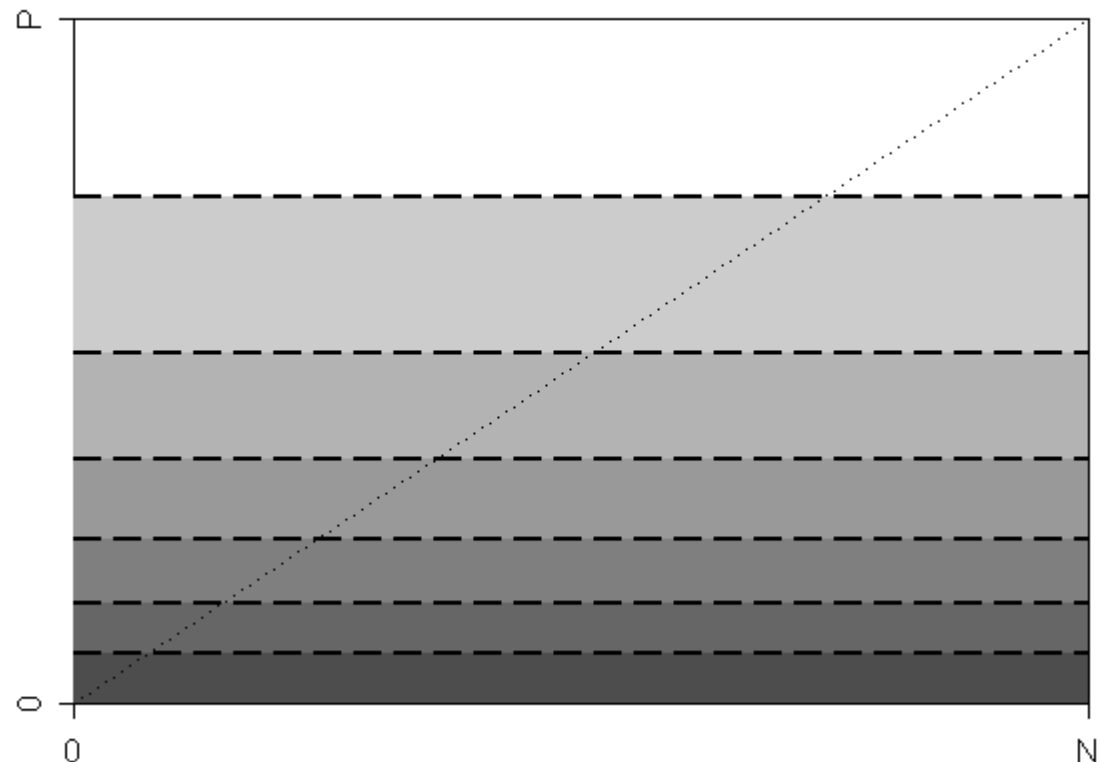

Anomaly of Foil's Stopping criterion

- We have tacitly assumed $N > P$...
- h_{MDL} assumes its maximum at $p = (P+N)/2$
 - thus, for $P > N$, the maximum is not on top!
- there may be rules
 - of equal length
 - covering the same number of negative examples
 - the rule covering fewer positive examples is acceptable
 - but the rule covering more positive examples is not!

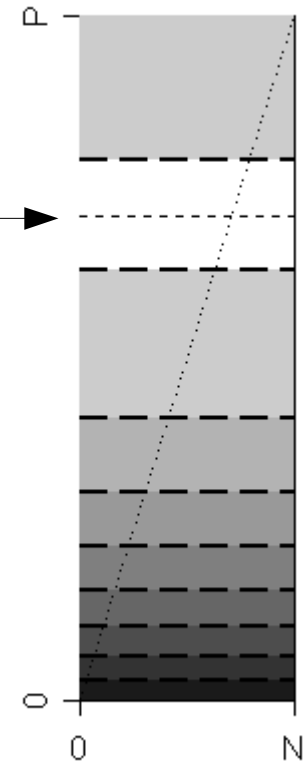

How Foil Works

- Foil (almost) implements Support/Confidence Filtering
(will be explained later → association rules)
- filtering of rules with no information gain
 - after each refinement step the region of acceptable rules is adjusted as in precision/confidence filtering
 - filtering of rules that exceed the rule length
 - after each refinement step the region of acceptable rules is adjusted as in support filtering

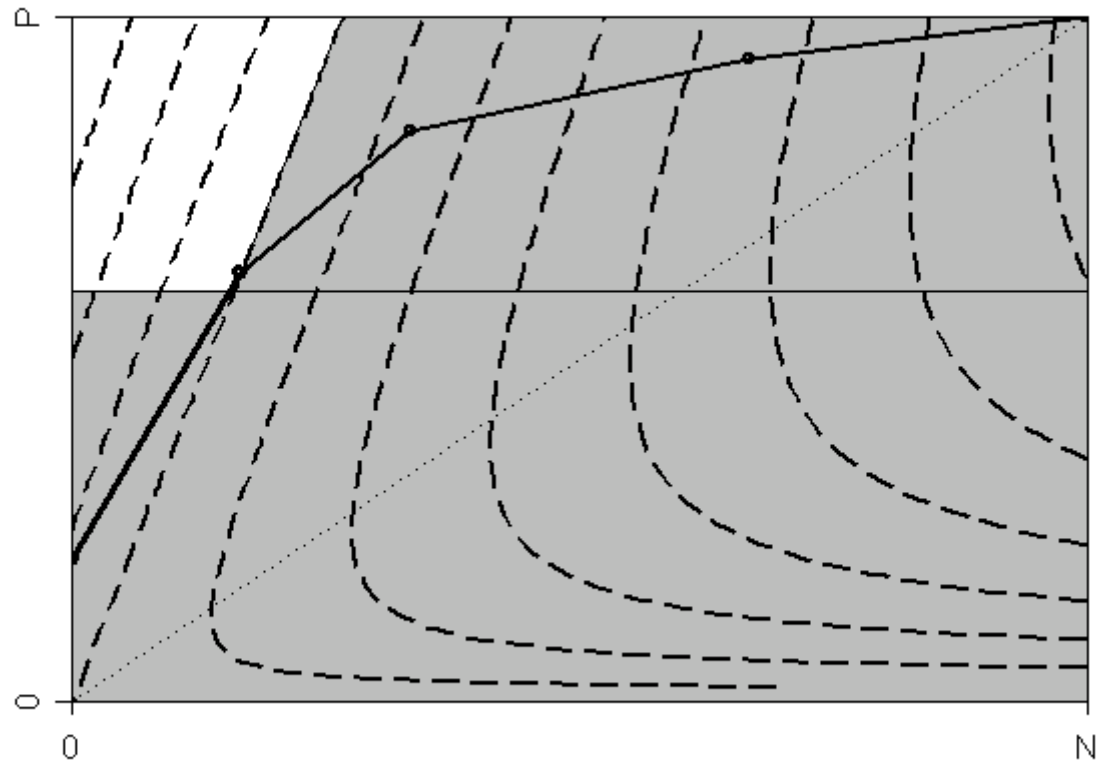

Pre-Pruning Systems

- Foil:
 - Search heuristic: Foil Gain
 - Pruning: MDL-Based
- CN2:
 - Search heuristic: Laplace/m-heuristic
 - Pruning: Likelihood Ratio
- Fossil:
 - Search heuristic: Correlation
 - Pruning: Threshold

Post Pruning

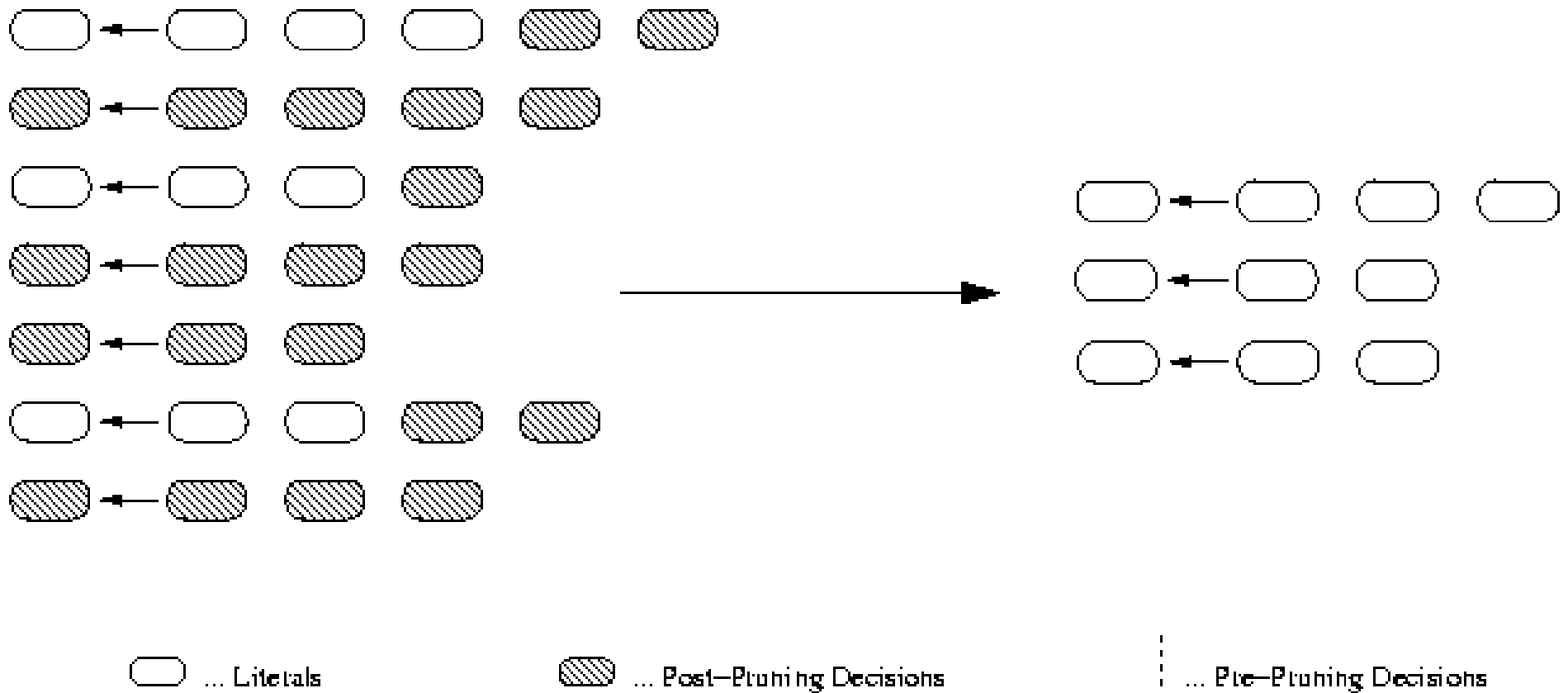

Post-Pruning: Example

IF	T=hot	AND	H=high	AND	O=sunny	AND	W=false	THEN	no
IF	T=hot	AND	H=high	AND	O=sunny	AND	W=true	THEN	no
IF	T=hot	AND	H=high	AND	O=overcast	AND	W=false	THEN	yes
IF	T=cool	AND	H=normal	AND	O=rain	AND	W=false	THEN	yes
IF	T=cool	AND	H=normal	AND	O=overcast	AND	W=true	THEN	yes
IF	T=mild	AND	H=high	AND	O=sunny	AND	W=false	THEN	no
IF	T=cool	AND	H=normal	AND	O=sunny	AND	W=false	THEN	yes
IF	T=mild	AND	H=normal	AND	O=rain	AND	W=false	THEN	yes
IF	T=mild	AND	H=normal	AND	O=sunny	AND	W=true	THEN	yes
IF	T=mild	AND	H=high	AND	O=overcast	AND	W=true	THEN	yes
IF	T=hot	AND	H=normal	AND	O=overcast	AND	W=false	THEN	yes
IF	T=mild	AND	H=high	AND	O=rain	AND	W=true	THEN	no
IF	T=cool	AND	H=normal	AND	O=rain	AND	W=true	THEN	no
IF	T=mild	AND	H=high	AND	O=rain	AND	W=false	THEN	yes

Reduced Error Pruning

- basic idea
 - optimize the accuracy of a rule set on a separate pruning set

0. split training data into a growing and a pruning set
1. learn a complete and consistent rule set covering all positive examples and no negative examples
2. as long as the error on the pruning set does not increase
 - delete condition or rule that results in the largest reduction of error on the pruning set
3. return the remaining rules

- accurate but not efficient
 - $O(n^4)$

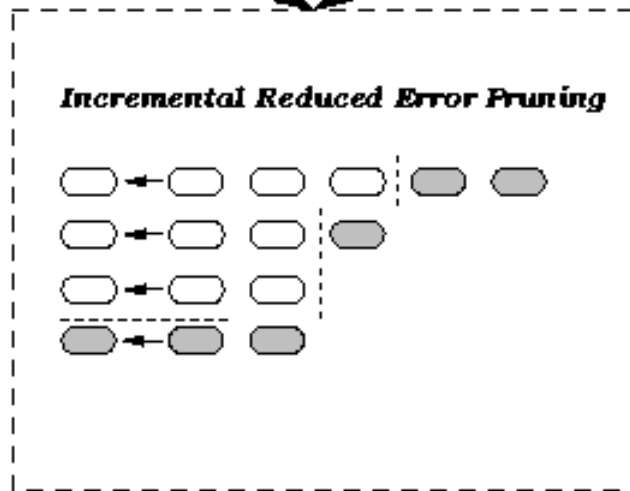
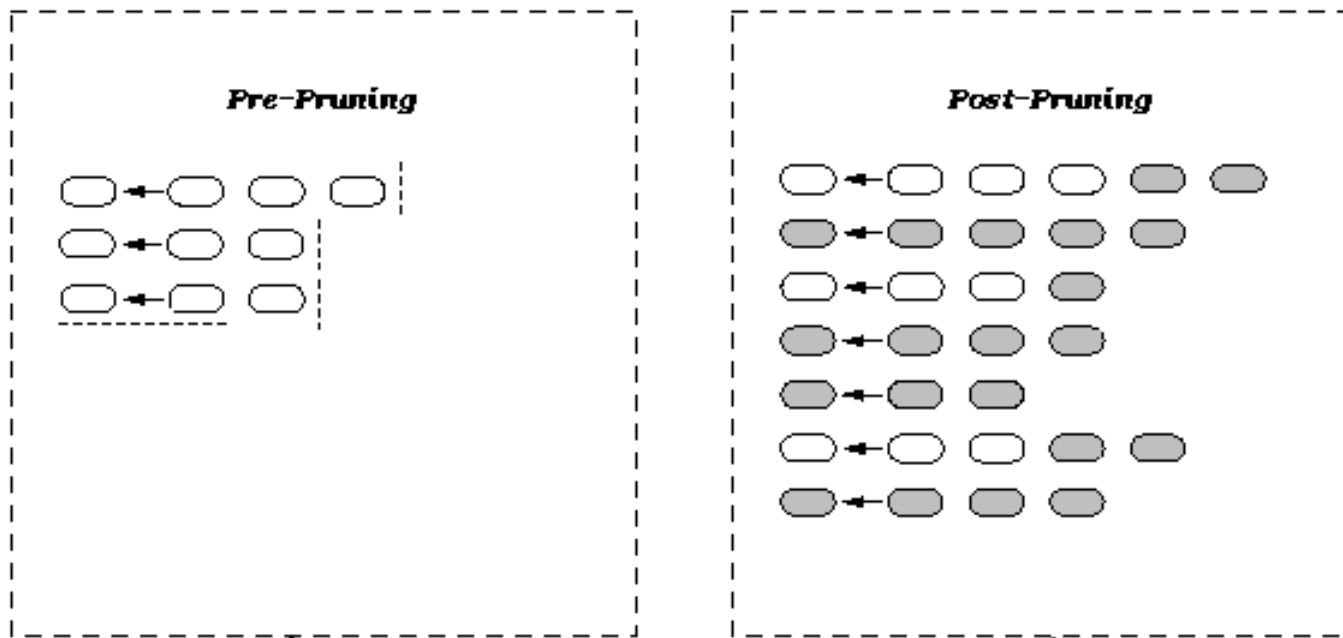

○ ... Literals

● ... Post-Pruning Decisions

⋮ ... Pre-Pruning Decisions

Incremental Reduced Error Pruning

- Prune each rule right after it is learned:
 1. split training data into a growing and a pruning set
 2. learn a consistent rule covering only positive examples
 3. delete conditions as long as the error on the pruning set does not increase
 4. if the rule is better than the default rule, add it to the rule set and goto 1.
- More accurate, much more efficient
 - because it does not learn overly complex intermediate concept
 - REP: $O(n^4)$ I-REP: $O(n \log^2 n)$
- Subsequently used in RIPPER rule learner (Cohen, 1995)
 - JRip in Weka

KRK(10% noise): Accuracy vs. Training Set Size

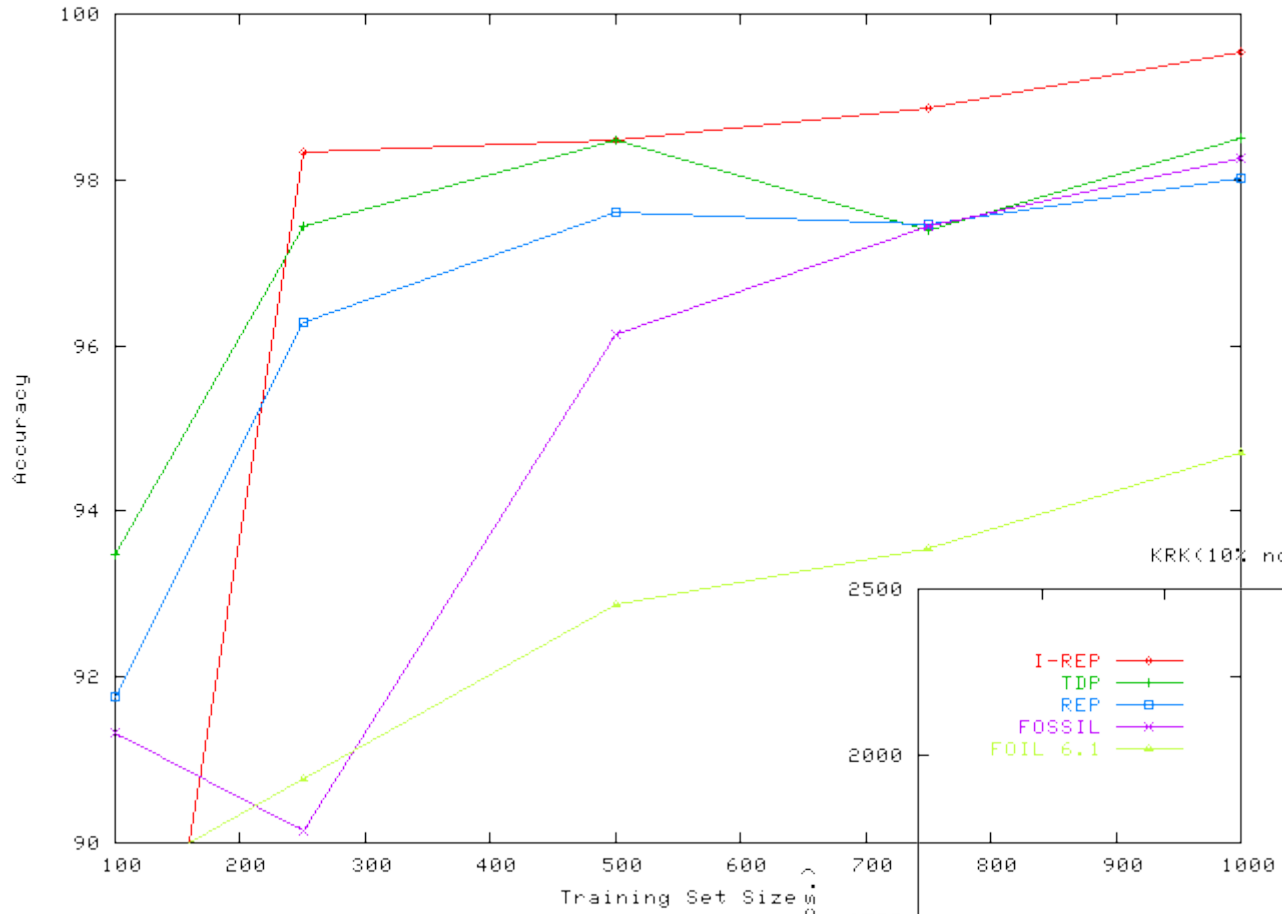

KRK(10% noise): Run-time vs. Training Set Size

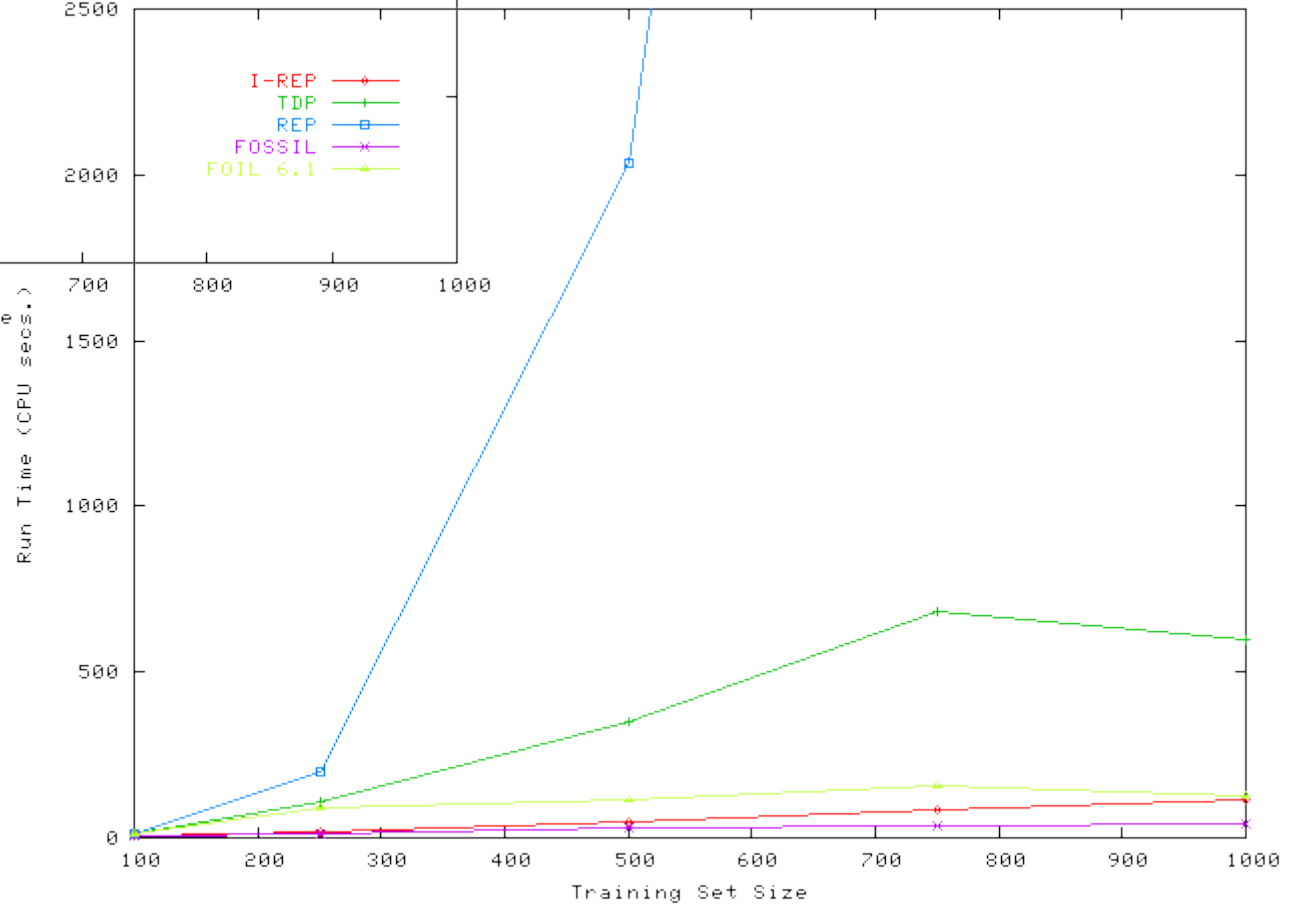

Multi-class problems

- **GOAL:** discriminate c classes from each other
- **PROBLEM:** many learning algorithms are only suitable for binary (2-class) problems
- **SOLUTION:**
"Class binarization":
Transform an c -class problem into a series of 2-class problems

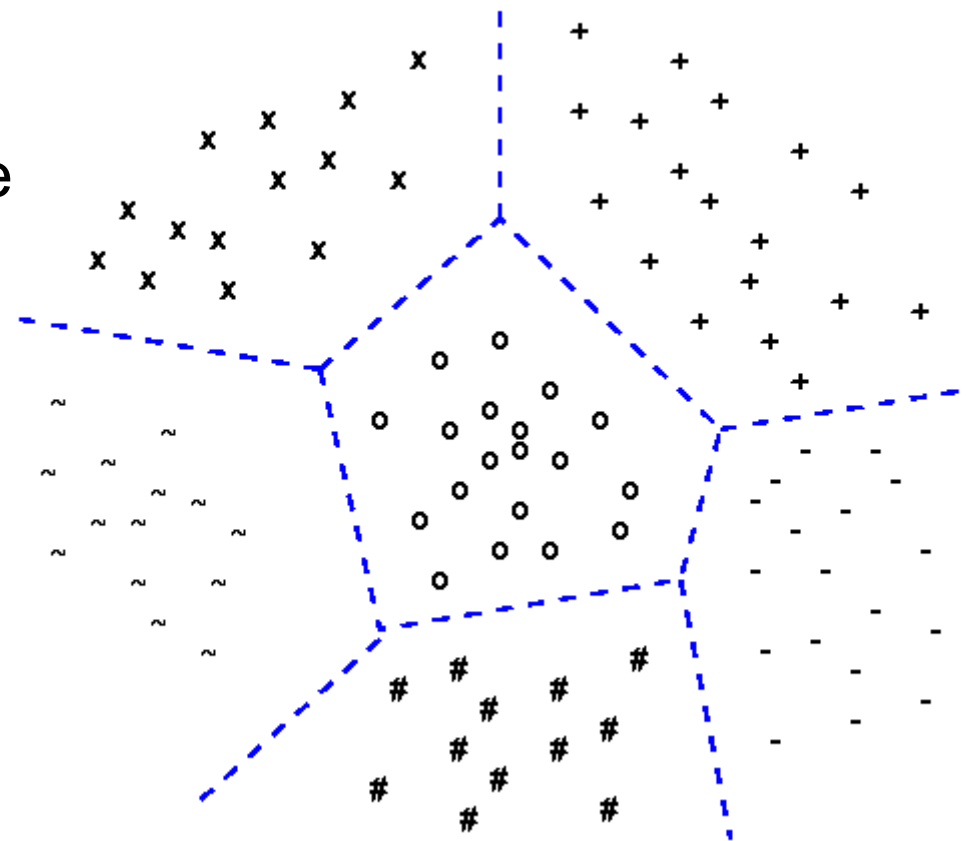

Class Binarization for Rule Learning

- None
 - class of a rule is defined by the majority of covered examples
 - decision lists, CN2 (Clark & Niblett 1989)
- One-against-all / unordered
 - foreach class c: label its examples positive, all others negative
 - CN2 (Clark & Boswell 1991), Ripper -a unordered
- Ordered
 - sort classes - learn first against rest - remove first - repeat
 - Ripper (Cohen 1995)
- Error Correcting Output Codes (Dietterich & Bakiri, 1995)
 - generalized by (Allwein, Schapire, & Singer, JMLR 2000)

One-against-all binarization

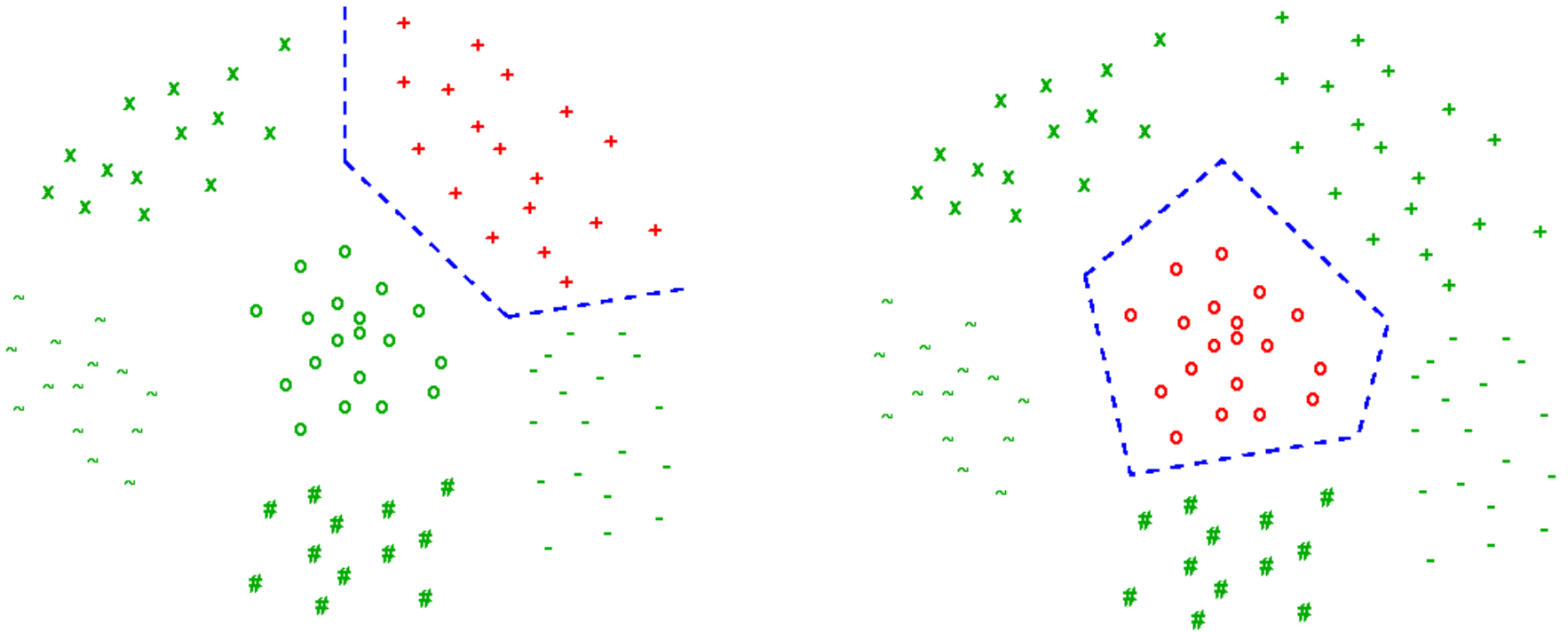

Treat each class as a separate concept:

- c binary problems, one for each class
- label examples of one class positive, all others negative

Prediction

- It can happen that multiple rules fire for a class
 - no problem for concept learning (all rules say +)
 - but problematic for multi-class learning
 - because each rule may predict a different class
 - Typical solution:
 - use rule with the highest (Laplace) precision for prediction
 - more complex approaches are possible: e.g., voting
- It can happen that no rule fires on a class
 - no problem for concept learning (the example is then -)
 - but problematic for multi-class learning
 - because it remains unclear which class to select
 - Typical solution: predict the largest class
 - more complex approaches:
 - e.g., rule stretching: find the most similar rule to an example

Round Robin Learning (aka *Pairwise Classification*)

- $c(c-1)/2$ problems
- each class against each other class

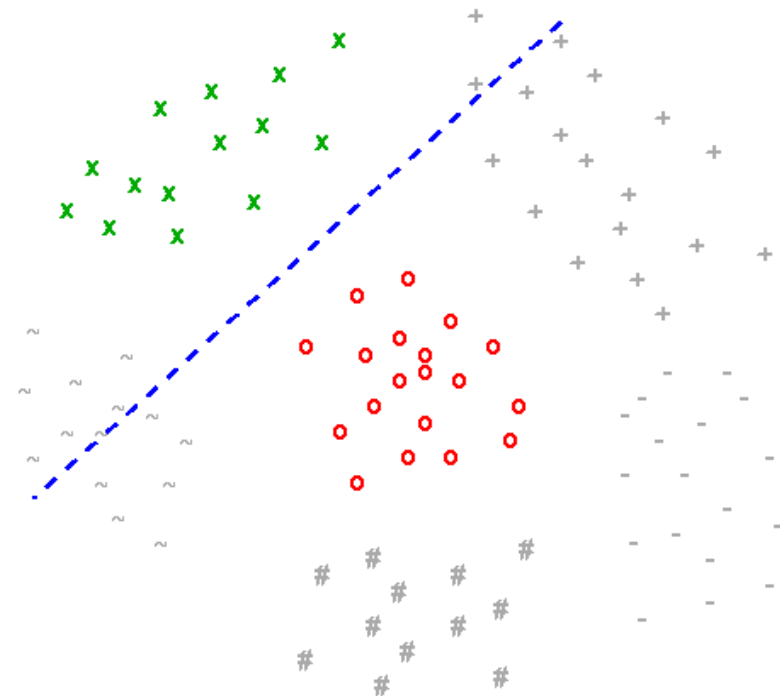
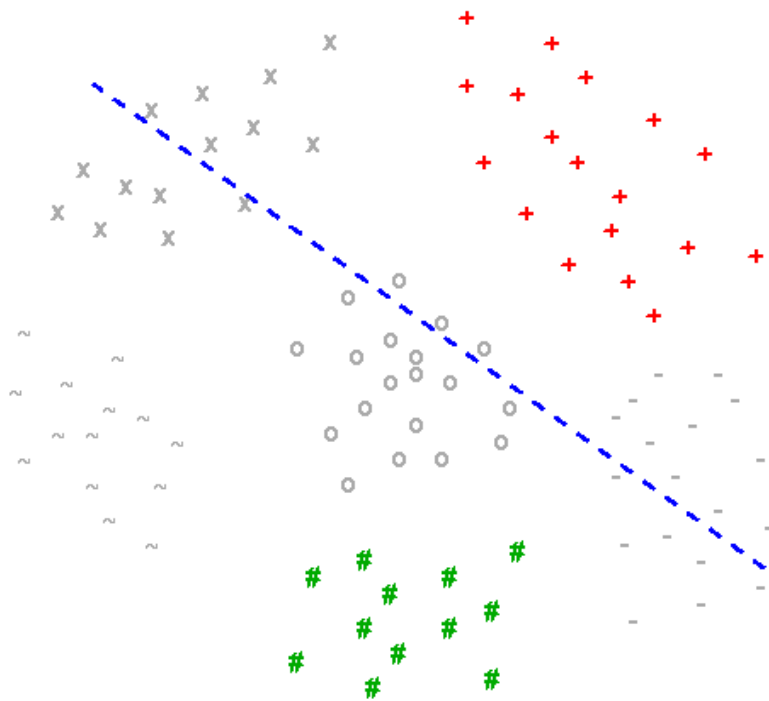

- ✓ smaller training sets
- ✓ simpler decision boundaries
- ✓ larger margins

Prediction

- Voting:
 - as in a sports tournament:
 - each class is a player
 - each player plays each other player, i.e., for each pair of classes we get a prediction which class „wins“
 - the winner receives a point
 - the class with the most points is predicted
 - tie breaks, e.g., in favor of larger classes
- Weighted voting:
 - the vote of each theory is proportional to its own estimate of its correctness
 - e.g., proportional to proportion of examples of the predicted class covered by the rule that makes the prediction

Accuracy

dataset	one-vs-all Ripper		pairwise		
	unord.	ordered	R ³	ratio	<
abalone	81.03	82.18	72.99	<i>0.888</i>	++
covertypes	35.37	38.50	33.20	<i>0.862</i>	++
letter	15.22	15.75	7.85	<i>0.498</i>	++
sat	14.25	17.05	11.15	<i>0.654</i>	++
shuttle	0.03	0.06	0.02	<i>0.375</i>	=
vowel	64.94	53.25	53.46	<i>1.004</i>	=
car	5.79	12.15	2.26	<i>0.186</i>	++
glass	35.51	34.58	25.70	<i>0.743</i>	++
image	4.15	4.29	3.46	<i>0.808</i>	+
lr spectrometer	64.22	61.39	53.11	<i>0.865</i>	++
optical	7.79	9.48	3.74	<i>0.394</i>	++
page-blocks	2.85	3.38	2.76	<i>0.816</i>	++
solar flares (c)	15.91	15.91	15.77	<i>0.991</i>	=
solar flares (m)	4.90	5.47	5.04	<i>0.921</i>	=
soybean	8.79	8.79	6.30	<i>0.717</i>	++
thyroid (hyper)	1.25	1.49	1.11	<i>0.749</i>	+
thyroid (hypo)	0.64	0.56	0.53	<i>0.955</i>	=
thyroid (repl.)	1.17	0.98	1.01	<i>1.026</i>	=
vehicle	28.25	30.38	29.08	<i>0.957</i>	=
yeast	44.00	42.39	41.78	<i>0.986</i>	=
average	21.80	21.90	18.52	<i>0.770</i>	

- error rates on 20 datasets with 4 or more classes
 - 10 significantly better ($p > 0.99$, McNemar)
 - 2 significantly better ($p > 0.95$)
 - 8 equal
 - never (significantly) worse

Yes, but isn't that expensive?

YES:

We have $O(c^2)$ learning problems...

but NO:

the total *training* effort is smaller than for the c learning problems in the one-against-all setting!

- Fine Print :
 - single round robin
 - more rounds add a constant factor
 - training effort only
 - test-time and memory are still quadratic
 - BUT: theories to test may be simpler

Advantages of Round Robin

- Accuracy
 - never lost against one-against-all
 - often significantly more accurate
- Efficiency
 - proven to be faster than, e.g., one-against-all, ECOC, boosting...
 - higher gains for slower base algorithms
- Understandability
 - simpler boundaries/concepts
 - similar to pairwise ranking as recommended by Pyle (1999)
- Example Size Reduction
 - each binary task is considerably smaller than original data
 - subtasks might fit into memory where entire task does not
- Easily parallelizable
 - each task is independent of all other tasks

A Pathology for Top-Down Learning

- Parity problems (e.g. XOR)
 - r relevant binary attributes
 - s irrelevant binary attributes
 - each of the $n = r + s$ attributes has values 0/1 with probability $\frac{1}{2}$
 - an example is positive if the number of 1's in the relevant attributes is even, negative otherwise
- Problem for top-down learning:
 - by construction, each condition of the form $a_i = 0$ or $a_i = 1$ covers approximately 50% positive and 50% negative examples
 - irrespective of whether a_i is a relevant or an irrelevant attribute
 - ➔ top-down hill-climbing cannot learn this type of concept
- Typical recommendation:
 - use *bottom-up learning* for such problems

Bottom-Up Approach: Motivation

IF	T=hot	AND	H=high	AND	O=sunny	AND	W=false	THEN	no
IF	T=hot	AND	H=high	AND	O=sunny	AND	W=true	THEN	no
IF	T=hot	AND	H=high	AND	O=overcast	AND	W=false	THEN	yes
IF	T=cool	AND	H=normal	AND	O=rain	AND	W=false	THEN	yes
IF	T=cool	AND	H=normal	AND	O=overcast	AND	W=true	THEN	yes
IF	T=mild	AND	H=high	AND	O=sunny	AND	W=false	THEN	no
IF	T=cool	AND	H=normal	AND	O=sunny	AND	W=false	THEN	yes
IF	T=mild	AND	H=normal	AND	O=rain	AND	W=false	THEN	yes
IF	T=mild	AND	H=normal	AND	O=sunny	AND	W=true	THEN	yes
IF	T=mild	AND	H=high	AND	O=overcast	AND	W=true	THEN	yes
IF	T=hot	AND	H=normal	AND	O=overcast	AND	W=false	THEN	yes
IF	T=mild	AND	H=high	AND	O=rain	AND	W=true	THEN	no
IF	T=cool	AND	H=normal	AND	O=rain	AND	W=true	THEN	no
IF	T=mild	AND	H=high	AND	O=rain	AND	W=false	THEN	yes

Bottom-Up Hill-Climbing

- Simple inversion of top-down hill-climbing
- A rule is successively *generalized*

1. Start with ~~an empty~~ rule R that covers ~~all examples~~
a fully specialized *a single example*
2. Evaluate all possible ways to ~~add~~ a condition to R
delete
3. Choose the best one
4. If R is satisfactory, return it
5. Else goto 2.

A Pathology of Bottom-Up Hill-Climbing

	<i>att1</i>	<i>att2</i>	<i>att3</i>
+	1	1	1
+	1	0	0
-	0	1	0
-	0	0	1

- Target concept $att1 = 1$ not (reliably) learnable with bottom-up hill-climbing
 - because no generalization of any seed example will increase coverage
 - Hence you either stop or make an arbitrary choice (e.g., delete attribute 1)

Bottom-Up Rule Learning Algorithms

- AQ-type:
 - select a seed example and search the space of its generalizations
 - **BUT:** search this space top-down
 - Examples: AQ (Michalski 1969), Progol (Muggleton 1995)
- based on least general generalizations (lggs)
 - greedy bottom-up hill-climbing
 - **BUT:** expensive generalization operator (*lgg/rlgg* of *pairs* of seed examples)
 - Examples: Golem (Muggleton & Feng 1990), DLG (Webb 1992), RISE (Domingos 1995)
- Incremental Pruning of Rules:
 - greedy bottom-up hill-climbing via deleting conditions
 - **BUT:** start at point previously reached via top-down specialization
 - Examples: I-REP (Fürnkranz & Widmer 1994), Ripper (Cohen 1995)

Algorithm	Language Bias					Search Bias							Overfitting Avoidance				
	Static					Dyn.		Algorithm				Strategy			Pre-Pruning	Post-Pruning	Integrated
	Selectors	Literals	Synt. Restr.	Rel. Clichés	Rule Models	Lang. Hier.	Constr. Ind.	Hill-Climbing	Beam Search	Best First	Stochastic	Top-Down	Bottom-Up	Bidirectional			
AQ	x							x	x			x					
AQL5	x							x	x			x					x
AQL7	x						x	x	x			x					
ATR15	x							x			x			x			x
BEXA	x							x	x			x				x	x
CHAMP	x	x	x					x	x			x				x	
C1PF	x						x	x				x					x
CN2	x							x	x			x					x
CN2-MCI	x						x	x	x			x					x
CLASS	x									x		x					
DLG	x							x	x				x				
FOCL	x	x		x				x				x					x
FOLL	x	x	x					x				x					x
FOSSIL	x	x	x	x				x				x					x
GA-SMART	x	x		x	x						x	x					x
GOLEM		x	x					x					x				
GREEDY3	x							x				x					x
GRENDEL					x			x				x					
GROW	x							x				x					x
HYDRA	x	x						x				x					
IBL-SMART	x	x		x						x				x			x
INDUCE	x	x						x	x			x					
1-REP, 1 ² -REP	x	x	x	x				x				x					x
JOJO	x	x						x						x			
m-FOLL	x	x	x					x	x			x					x
MDL-FOLL	x	x	x					x				x					x
MILP	x	x	x								x	x					x
ML-SMART	x	x		x				x	x	x		x					x
NINA					x	x		x					x				
POSEIDON	x							x	x			x					x
PREPEND	x							x				x					
PRISM	x							x				x					
PROGOL	x	x	x							x		x					
REP	x	x		x				x				x					x
RIPPER	x			x				x				x					x
RDT					x			x				x					
SFOLL	x											x					x
SLA	x											x					x
SMART+	x	x		x	x			x	x	x		x					x
SWAP-1	x							x						x			x
TDP	x	x	x	x				x				x					x

- language bias:
 - ◆ which type of conditions are allowed (static)
 - ◆ which combinations of conditions are allowed (dynamic)
- search bias:
 - ◆ search heuristics
 - ◆ search algorithm (greedy, stochastic, exhaustive)
 - ◆ search strategy (top-down, bottom-up)
- overfitting avoidance bias:
 - ◆ pre-pruning (stopping criteria)
 - ◆ post-pruning